

Cargo Control & Vehicle Maintenance



Quick Reference Catalog

Cargo Control Index

Brake Control	Breakaway Systems	Pg. 11-12
	Proportional Brake Control Accessories	Pg. 11
	Proportional Brake Controls	Pg. 10
Cable & Plug Assemblies	4-Way Plugs & Sockets	Pg. 15
	6-Way Plugs & Sockets	Pg. 15
	7-Way Plugs & Sockets	Pg. 14
	7-Way RV Style Sockets	Pg. 16
	Coiled Cable Assembly	Pg. 13-14
	Coiled Cable Assembly, ABS	Pg. 13
	Molded In-Line Connectors	Pg. 16
	Molded Trailer End Connector & Cable	Pg. 17
	RV Connector Adapters	Pg. 16
	Single & Double Pole Plugs & Sockets	Pg. 15
	Truck Trailer to Trailer Adapters	Pg. 17
Cargo Control	Ball Hitches	Pg. 1
	Combination Ball Hitches	Pg. 1
	Couplers	Pg. 3
	Hitch Balls	Pg. 2
	Multi-Ball Hitches	Pg. 1
	Pintle Hook Mounts	Pg. 4
	Pintle Hooks	Pg. 4
	Receiver Tubes	Pg. 3
	Towing Ball Mounts	Pg. 2
	Trailer Jacks	Pg. 4
	Travel Control & Choke Cables	Pg. 5
	Vernier Cables	Pg. 5
	Chain & Hardware	Chain
E-Track		Pg. 9
E-Track Accessories		Pg. 9
Forged Lashing Rings (D-Rings)		Pg. 8
Hooks		Pg. 7
Lever Binders		Pg. 8
Ratchet Binders		Pg. 8
Ratchet Straps		Pg. 8
Rubber Clamps		Pg. 9
Rubber Tarp Straps		Pg. 9
Winch Straps		Pg. 8

Vehicle Maintenance Index

Electrical	Battery Disconnect Switches	Pg. 20	
	Flashers	Pg. 22	
	Halogen Bulbs	Pg. 24-25	
	Ignition Starter Switches	Pg. 18-19	
	Lamp Sockets	Pg. 27	
	Miniature Bulbs	Pg. 23-24	
	Pilot Lights	Pg. 26	
	Push-Button Switches	Pg. 18	
	Relays	Pg. 21	
	Sealed Beams	Pg. 25-26	
	Solenoid Switches	Pg. 20	
	Truck Mirrors	Convex Mirrors	Pg. 28
		Convex Mirrors, Stick-On	Pg. 29
Light & Medium Duty Mirrors		Pg. 29	
School Bus Mirrors		Pg. 29	
West Coast Mirrors		Pg. 28	
Wide Angle Mirrors		Pg. 29	

Ball Hitches (Black Powder Coat Finish)

6-Ton Receiver Mount Combination Hitch

Single piece drop forged lower jaw is designed with an integral shank to fit 2" receiver tubes.

Technical Data:

Drawbar Dimensions 2-1/2" to 3" ID with 1-1/4" to 1-9/16" diameter section

M.V.L. 2,400 Lbs.

M.G.T.W. 12,000 Lbs.

BPC-RM61780 1-7/8" Ball

BPC-RM62000 2" Ball

BPC-RM62516 2-5/16" Ball



8-Ton Combination Hitch

Drop forged hitch with interchangeable forged steel hitch ball.

Technical Data:

Drawbar Dimensions 2-1/2" to 3" ID with 1-1/4" to 1-9/16" diameter section

M.V.L. 3,000 Lbs.

M.G.T.W. 16,000 Lbs.

BPC-BH81780 1-7/8" Ball

BPC-BH82000 2" Ball

BPC-BH82516 2-5/16" Ball



10-Ton Combination Hitch

Drop forged hitch with interchangeable forged steel hitch ball.

Technical Data:

Drawbar Dimensions 2-3/8" to 3" ID with up to 1-9/16" diameter section

M.V.L. 4,000 Lbs.

M.G.T.W. 20,000 Lbs.

BPC-BH102000 2" Ball

BPC-BH102516 2-5/16" Ball



Multi-Ball Hitches (Black Powder Coat Finish)

Tri-Ball Hitch

Solid shank for 2" receiver tubes, with a 5/8" hitch pin hole. Includes all three towing ball sizes.

MGTW:

1-7/8" 6,000 Lbs.

2" 7,500 Lbs

2-5/16" 10,000 Lbs

BPC-1802200 Black Towing Balls

BPC-1802205 Chrome Towing Balls



Adjustable Tri-Ball Hitch

Solid shank for 2" receiver tubes has 12" of verticle adjustment, with a 5/8" hitch pin hole. Includes all three towing ball sizes.

MGTW:

1-7/8" 6,000 Lbs.

2" 7,500 Lbs

2-5/16" 10,000 Lbs

BPC-1802225 Chrome Towing Balls



A-B 1-1/4" Shank Towing Ball Mount

Fits 1-1/4" receiver tubes. Tongue accepts 3/4" diameter shank towing balls.

C-G 2" Shank Towing Ball Mount

Fits 2" receiver tubes. Tongue accepts 1" diameter shank towing balls.

H 2" Heavy Duty Ball Mount

Fits 2" receiver tubes. Tongue accepts 1" and 1-1/4" diameter shank towing balls.

I 2-1/2" Shank Towing Ball Mount

Fits 2-1/2" receiver tubes. Tongue accepts 1-1/4" diameter shank towing balls.



	Description	Length	Max Drop	M.V.L. (Lbs.)	M.G.T. (Lbs.)	Part No.
A	Ball Mount	9"	1-1/4"	300	3500	BPC-1803100CR
B	Ball Mount	7"	2-1/2"	300	3500	BPC-1803105
B	Ball Mount	7"	4"	300	3500	BPC-1803110
C	Straight Ball Mount	8"	2"	600	6000	BPC-1803005
D	Straight Ball Mount, Chrome Plated	8"	2"	600	6000	BPC-1803006
C	Straight Ball Mount	10"	2"	600	6000	BPC-1803007
C	High-Low Ball Mount	8"	4"	600	6000	BPC-1803010
D	High-Low Ball Mount, Chrome Plated	8"	4"	600	6000	BPC-1803011
E	High-Low Ball Mount	10"	4"	600	6000	BPC-1803013
E	Deep Drop Ball Mount	10"	6"	600	6000	BPC-1803015
D	Deep Drop Ball Mount, Chrome Plated	10"	6"	600	6000	BPC-1803016
E	Deep Drop Ball Mount	10"	8"	600	6000	BPC-1803017
E	Deep Drop Ball Mount, Solid Shank	10.28"	10-1/4"	350	6000	BPC-1803019
F	Straight Ball Mount, Stainless Steel	8"	2"	600	6000	BPC-1803070
F	Straight Ball Mount, Stainless Steel	9-1/2"	3"	600	6000	BPC-1803073
G	Ball Mount, Forged Aluminum	7-1/4"	2"	1000	10000	BPC-1803505
G	Ball Mount, Forged Aluminum	7-1/4"	3-1/4"	1000	10000	BPC-1803510
H	Heavy Duty Solid Ball Mount, 1" Hole	7.63"	2"	2000	20000	BPC-1803050
H	Heavy Duty Solid Ball Mount, 1-1/4" Hole	7.63"	2"	2000	20000	BPC-1803051
H	Heavy Duty Solid Ball Mount, 1" Hole	7.88"	4"	2000	20000	BPC-1803055
H	Heavy Duty Solid Ball Mount, 1-1/4" Hole	7.88"	4"	2000	20000	BPC-1803056
H	Heavy Duty Solid Ball Mount, 1" Hole	9.37"	6"	1700	17000	BPC-1803058
H	Heavy Duty Solid Ball Mount, 1-1/4" Hole	9.37"	6"	1700	17000	BPC-1803059
I	Straight Ball Mount	10"	3"	1200	12000	BPC-1803405
I	High-Low Ball Mount	10"	5"	1200	12000	BPC-1803410

Hitch Balls

Finish	Ball Diameter	Shank Diameter	Shank Length	M.G.T.W. (Lbs.)	Part No.
Chrome	2"	1"	2-1/8"	5000	BPC-1802005
	2"	1"	2-3/4"	10000	BPC-1802007
	2"	3/4"	2-1/8"	3500	BPC-1802010
	1-7/8"	3/4"	2-1/8"	3500	BPC-1802015
	1-7/8"	1"	2-1/8"	5000	BPC-1802020
	2-5/16"	1-1/4"	2-3/4"	10000	BPC-1802025
	2-5/16"	1"	2-1/8"	7500	BPC-1802026
	2-5/16"	1"	2-1/8"	10000	BPC-1802027
Stainless Steel	1-7/8"	1"	2-1/8"	5000	BPC-1802070
	2"	1"	2-1/8"	7000	BPC-1802075



1-1/4", 2", or 2-1/2" receiver tubes available in plain or black powder coat finish.

Solid stress collar opening with 5/8" hitch pin hole (2" & 2-1/2") or 1/2" hitch pin hole (1-1/4")

* Receiver Tube Adapters are also available

Dimensions (ID x Length)	Finish	Part No.
1-1/4" x 6"	Plain	BPC-RT1251206
2" x 6"		BPC-RT25806
2-1/2" x 8"		BPC-RT255808
2-1/2" x 12"		BPC-RT255812
2" x 6"	Black	BPC-RT25806B
2" x 8"	Plain	BPC-RT25808
2" x 8"	Black	BPC-RT25808B
2" x 10"	Plain	BPC-RT25810
2" x 10"	Black	BPC-RT25810B
2" x 12"	Plain	BPC-RT25812
2" x 12"	Black	BPC-RT25812B
2" x 14"	Plain	BPC-RT25814
2" x 14"	Black	BPC-RT25814B



Couplers (Straight and Adjustable)

2", 2-1/2", or 3" Channel Straight Tongue Couplers

Can be bolted or welded to trailer frame.

Technical Data:

1-7/8" Ball M.G.T.W. 2,000 Lbs.

2" Ball M.G.T.W. 3,500 Lbs.

- BPC-0091050** 1-7/8" Ball x 2" Channel
- BPC-0091052** 1-7/8" Ball x 2-1/2" Channel
- BPC-0091055** 1-7/8" Ball x 3" Channel
- BPC-0091058** 2" Ball x 2" Channel
- BPC-0091060** 2" Ball x 2-1/2" Channel
- BPC-0091065** 2" Ball x 3" Channel



Adjustable Tongue Couplers

Zinc plated latch with safety pin included. Assembly comes complete with coupler and 3 or 5 position channel.

Technical Data:

2" Ball M.G.T.W. 10,000 Lbs.

2-5/16" Ball M.G.T.W. 12,000 Lbs.

- BPC-0090150** 2" Coupler Only
- BPC-0090100** 2-5/16" Coupler Only
- BPC-0090155** 2" Assembly w/ 3-Pos. Channel
- BPC-0090160** 2" Assembly w/ 5-Pos. Channel
- BPC-0090105** 2-5/16" Assembly w/ 3-Pos. Channel
- BPC-0090110** 2-5/16" Assembly w/ 5-Pos. Channel



Pintle Hooks (Black Powder Coat Finish)

Description	M.V.L. (Lbs.)	M.G.T.W. (Lbs.)	Part No.
5-Ton	2000	10000	BPC-PH5
8-Ton	3200	16000	BPC-PH8
15-Ton	6000	30000	BPC-PH15
20-Ton	8000	40000	BPC-PH20
30-Ton	15000	60000	BPC-PH30



Pintle Hook Mounts (Black Powder Coat Finish)

Shank Dimensions	Plate Dimensions	Pair of Holes	M.V.L. (Lbs.)	M.G.T.W. (Lbs.)	Part No.
2" x 9"	5" x 3.75"	2	4000	20000	BPC-PM84
2" x 9"	5" x 7.38"	4	2000	10000	BPC-PM87
2" x 10.25"	5" x 5.75"	3	2800	14000	BPC-PM105
2" x 10.25"	4" x 7.38"	4	2000	10000	BPC-PM107
2" x 12.25"	5" x 12.50"	7	2000	10000	BPC-PM812
2" x 14.05"	5" x 12.50"	7	2000	10000	BPC-PM1012
2.5" x 12"	5" x 6.13"	3	3200	16000	BPC-PM25612



Trailer Jacks

Description		Capacity (Lbs.)	Travel	Wind	Part No.
Tube	Swivel	2000	10"	Top	BPC-0091205
Bracket	Swivel	2000	10"		BPC-0091210
Tube	Swivel	2000	15"		BPC-0091215
Tube	Swivel	5000	10"	Side	BPC-0091220
Bracket	Swivel	2000	15"	Top	BPC-0091225
A-Frame	Includes Support Foot	2000	15"		BPC-0091260
A-Frame	Jack Only	2000	15"		BPC-0091261
A-Frame	Includes Support Foot	5000	15"		BPC-0091265
A-Frame	Jack Only	5000	15"		BPC-0091266
2-1/2" Square Tube		7000	26"		BPC-0091310
2-1/2" Square Tube		7000	26"	Side	BPC-0091340
4" Square HD	Side Pin Jack w/ Handle	10000 Dynamic	12" Screw Travel w/ 14" Adj.		BPC-0091410H
4" Square HD	Side Pin Jack	10000 Dynamic			BPC-0091410
4" Square HD	Front Pin Jack w/ Handle	10000 Dynamic			BPC-0091415H
4" Square HD	Front Pin Jack	10000 Dynamic			BPC-0091415
Handle for 0091410 and 0091415					BPC-0091405H



Tube Style



A-Frame Style



Square Tube Style



HD Square Style

A-B 3100 Series Vernier Adjustable Locking Control Cables

3/4"-16 UNF, .260 diameter conduit and .075 diameter stainless steel core.

C Vernier Adjustable Locking Control Cable Head

O-ring sealed plunger assembly suitable for exterior applications. Adjustable friction collet assures stable settings in the presence of sever vibration. Dual locking balls provide increased load range and extended plunger life.



	Description	Part No.
A	6 ft. Control Cables	BPC-VCGT3100X06
	10 ft. Control Cables	BPC-VCGT3100X10
	15 ft. Control Cables	BPC-VCGT3100X15
	20 ft. Control Cables	BPC-VCGT3100X20
	25 ft. Control Cables	BPC-VCGT3100X25
	30 ft. Control Cables	BPC-VCGT3100X30
	35 ft. Control Cables	BPC-VCGT3100X35
B	6 ft. Heavy Duty Control Cables	BPC-VCGTX06
	10 ft. Heavy Duty Control Cables	BPC-VCGTX10
	15 ft. Heavy Duty Control Cables	BPC-VCGTX15
	20 ft. Heavy Duty Control Cables	BPC-VCGTX20
	25 ft. Heavy Duty Control Cables	BPC-VCGTX25
	30 ft. Heavy Duty Control Cables	BPC-VCGTX30
	35 ft. Heavy Duty Control Cables	BPC-VCGTX35
C	Vernier Cable Head Only	BPC-VCGTHO

Travel Control & Choke Cables

RO5B Series 5" Travel Control Cables

Chelsea replacement cables are 3/8"-24 thd and 1/2"-20 thd. .312 diameter spiral wound conduit, with .085 diameter stainless steel core.

Length	Travel Control	Choke Cable
6'	BPC-RO5B5X06	BPC-R21CX06
8'		BPC-R21CX08
10'	BPC-RO5B5X10	BPC-R21CX10
12'	BPC-RO5B5X12	
15'	BPC-RO5B5X15	BPC-R21CX15
20'	BPC-RO5B5X20	
25'	BPC-RO5B5X25	
30'	BPC-RO5B5X30	



EL-Cor offers a complete line of products from Buyers Products Company, including:

- | | | | | | |
|--------------|--------------|------------------------|-------------------|--------------|----------------|
| Hitch Plates | Towing Hooks | Window Protectors | Truck Light Boxes | Rope Rings | Paddle Latches |
| Hood Catches | Hinges | Handles & Steps | Yoke Ends | Wheel Chocks | Sight Rods |
| Gauges | Filters | Ball Joints & Bearings | Rubber Bumpers | | |

* Please call for a complete catalog featuring Buyers Products

High Test Chain (P43, Electro-Galvanized)

Chain Size	Length	Weight (Lbs.)	Working Load Limit	Part No.
1/4"	133 ft. Pail	96	2600 Lbs.	WES-0181413
	800 ft. Full Drum	560		WES-018143-800
	400 ft. Half Drum	282		WES-018143-400
5/16"	90 ft. Pail	92	3900 Lbs.	WES-0181513
	550 ft. Full Drum	558		WES-0181513-550
	275 ft. Half Drum	281		WES-0181513-275
3/8"	60 ft. Pail	93	5400 Lbs.	WES-0181613
	400 ft. Full Drum	588		WES-0181613-400
	200 ft. Half Drum	296		WES-0181613-200
1/2"	33 ft. Pail	100	9200 Lbs.	WES-0181813
	200 ft. Full Drum	538		WES-0181813-200
	100 ft. Half Drum	271		WES-0181813-100

**Transport Chain (G70, Gold Chromate)**

Chain Size	Length	Weight (Lbs.)	Working Load Limit	Part No.
1/4"	150 ft. Pail	113	3150 Lbs.	WES-0191413
	800 ft. Full Drum	601		WES-019143-800
	400 ft. Half Drum	282		WES-019143-400
5/16"	100 ft. Pail	102	4700 Lbs.	WES-0191513
	550 ft. Full Drum	560		WES-0191513-550
	275 ft. Half Drum	281		WES-0191513-275
3/8"	66 ft. Pail	97	6600 Lbs.	WES-0191613
	400 ft. Full Drum	588		WES-0191613-400
	200 ft. Half Drum	303		WES-0191613-200
1/2"	33 ft. Pail	90	8750 Lbs.	WES-0191813
	200 ft. Full Drum	528		WES-0191813-200
	100 ft. Half Drum	270		WES-0191813-100

**Binder Chains (G70 Transport Chain with G70 Clevis Grab Hooks)**

Chain Size	Length	Weight (Lbs.)	Working Load Limit	Part No.	Bulk Qty.
5/16"	16 ft.	17.60	4700 Lbs.	WES-BCG705616	25
	20 ft.	21.52		WES-BCG705620	25
3/8"	16 ft.	25.40	6600 Lbs.	WES-BCG703816	25
	20 ft.	31.50		WES-BCG703820	20
1/2"	16 ft.	47.70	11300 Lbs.	WES-BCG705016	10
	20 ft.	58.30		WES-BCG705020	10

**Also Available:**

- Grade 80 Alloy Chain and Hooks
- Proof Coil Chain (P30)
- Machine Chain (Low Carbon Steel Chain) (Special Order)
- Coil Chain (Light Duty) (Special Order)
- Passing Link Chain (Special Order)
- Double Loop, Lock Link, Plumbers, and Single Jack chain (Special Order)

Clevis Grab Hooks

Chain Size	Working Load Limit	High-Test (P43) Part No.
1/4"	2600 Lbs.	WES-4500405
5/16"	3900 Lbs.	WES-4500505
3/8"	5400 Lbs.	WES-4500605
1/2"	9200 Lbs.	WES-4500805

Chain Size	Working Load Limit	Transport (G70) Part No.
1/4"	3150 Lbs.	WES-8500405
5/16"	4700 Lbs.	WES-8500505
3/8"	6600 Lbs.	WES-8500605
1/2"	11300 Lbs.	WES-8500805



Clevis Slip Hooks

Chain Size	Working Load Limit	High-Test (P43) Clevis Slip Hook	High-Test (P43) Clevis Safety Slip
1/4"	2600 Lbs.	WES-4300405	WES-4400405
5/16"	3900 Lbs.	WES-4300505	WES-4400505
3/8"	5400 Lbs.	WES-4300605	WES-4400605
1/2"	9200 Lbs.	WES-4300805	WES-4400805



Chain Size	Working Load Limit	Transport (G70) Clevis Safety Slip
1/4"	3150 Lbs.	WES-8400405
5/16"	4700 Lbs.	WES-8400505
3/8"	6600 Lbs.	WES-8400605
1/2"	11300 Lbs.	WES-8400805



Double Clevis (G70)

Size	Working Load Limit	Part No.
1/4" x 5/16"	4700 Lbs.	WES-5400505
3/8" x 3/8"	6600 Lbs.	WES-5400605
7/16" x 1/2"	11300 Lbs.	WES-5400805



Quick Links

Chain Size	Working Load Limit	Electro Galvanized
1/8"	220 Lbs.	WES-5300205
3/16"	615 Lbs.	WES-5300305
1/4"	880 Lbs.	WES-5300404
5/16"	1760 Lbs.	WES-5300504
3/8"	2200 Lbs.	WES-5300604
1/2"	3300 Lbs.	WES-5300804



Screw Pin Shackles

Size	Galvanized	Stainless Steel
3/16"	CHC-20105-6	CHC-20105-6SS
1/4"	CHC-20110-0	CHC-20110-0SS
5/16"	CHC-21115-5	CHC-21115-5SS
3/8"	CHC-20120-9	CHC-20120-9SS
7/16"	CHC-20125-4	CHC-20125-4SS
1/2"	CHC-20130-8	CHC-20130-8SS
5/8"	CHC-20135-3	CHC-20135-3SS
3/4"	CHC-20140-7	CHC-20140-7SS
7/8"	CHC-20145-2	CHC-20145-2SS
1"	CHC-20150-6	CHC-20150-6SS



* Also available in Bolt Type, and Round Pin Type upon request

Forged Lashing Rings (D-Rings)

Ring Diameter	I.D. (H x W)	Bracket Size Width x Thickness	Working Load Limit	Ultimate Breaking Strength	Part No.
1/2"	2-1/2" x 2-3/8"	2" x 11/16"	4080 Lbs.	11781 Lbs.	BPC-B38
5/8"	3" x 3"	2-1/2" x 3/8"	6130 Lbs.	18390 Lbs.	BPC-B40
3/4"	3" x 3"	2-1/4" x 3/8"	9120 Lbs.	26500 Lbs.	BPC-B46
1"	3" x 3"	2-1/8" x 3/8"	15586 Lbs.	46760 Lbs.	BPC-B48
1"	4" x 3"	2-1/8" x 3/8"	15586 Lbs.	46760 Lbs.	BPC-B50



BPC-B38



BPC-B40



BPC-B46



BPC-B48



BPC-B50

Load Binding Systems

Type	Chain Size (Min - Max)	Working Load Limit	Handle Length	Take-Up	Part No.
Lever Binder (All Forged)	1/8" - 1/8"	375 Lbs.			WES-DM-1
	3/8" - 5/16"	5400 Lbs.			WES-DB-11
	3/8" - 5/16"	7100 Lbs.			WES-DF-7100
	3/8" - 5/16"	6600 Lbs.			WES-DBX-6600
Ratchet Binder (Proof Tested)	1/4" - 3/16"	2600 Lbs.	15.5"	8"	WES-LDR-14
	3/8" - 5/16"	6600 Lbs.			WES-DR-1
	1/2" - 3/8"	9200 Lbs.			WES-DR-2
	5/8" - 1/2"	13000 Lbs.			WES-DR-3



Ratchet Straps

Type	Width	Length	Working Load Limit	Part No.
Flat Hooks	2"	27 ft.	3335 Lbs.	RS-2-27-FH
	3"	27 ft.	5400 Lbs.	RS-3-27-FH
	3"	30 ft.	5400 Lbs.	RS-3-30-FH
	4"	30 ft.	6600 Lbs.	RS-4-30-FH
Wire Hooks	1-1/2"	15 ft.	4000 Lbs.	RS-15-15-JH
	2"	27 ft.	3335 Lbs.	RS-2-27-JH
	2"	30 ft.	5400 Lbs.	RS-2-30-JH
	3"	27 ft.	5700 Lbs.	RS-3-27-JH
	3"	30 ft.	5000 Lbs.	RS-3-30-JH
Chain Anchor	2"	27 ft.	3335 Lbs.	RS-2-27-CH
D-Ring	1"	16 ft.	1000 Lbs.	RS-1-16-JH-D



Winch Straps

Type	Width	Length	Working Load Limit	Part No.
Flat Hooks	2"	27 ft.	3335 Lbs.	WS-2-27-FH
	2"	30 ft.	3335 Lbs.	WS-2-30-FH
	3"	27 ft.	5000 Lbs.	WS-3-27-FH
	3"	30 ft.	5400 Lbs.	WS-3-30-FH
	4"	27 ft.	6600 Lbs.	WS-4-27-FH
	4"	30 ft.	5000 Lbs.	WS-4-30-FH
Chain Anchor	3"	27 ft.	5000 Lbs.	WS-3-27-CH
	3"	30 ft.	5000 Lbs.	WS-3-30-CH
	4"	30 ft.	6600 Lbs.	WS-4-30-CH



Size	Span Range	Part No.
5"	10" to 15"	TS-5
10"	15" to 20"	TS-10
15"	20" to 30"	TS-15
21"	30" to 40"	TS-21
31"	40" to 55"	TS-31
41"	50" to 60"	TS-41



Standard Package Qty: 10, 50, 100

Rubber Clamps

Ideal for securing shovels, axes, hoses, and fire extinguishers.

Use on work vehicles, off-road trucks, law enforcement vehicles, fire trucks, or to mount on walls. Constructed of transporting grade rubber, this clamp is not effected by heat or cold, and is UV resistant.

BPC-RC10S:

Holds objects 1" to 2-1/2" diameter (Supports 22 Lbs.)

BPC-RC10L:

Holds objects 2-1/2" to 9-1/2" diameter (Supports 50 Lbs.)



E-Track

Designed to offer the user the proper anchor point, and the right location every time.

E-Track works great on both open and closed trailers. Constructed of heavy 12 gauge steel, with mounting holes at 2" increments. Offers adjustable anchor points and is powder coated gunmetal grey.

- BPC-1903052** 2 ft. Section
- BPC-1903055** 5 ft. Section
- BPC-1903050** 10 ft. Section



E-Track Accessories

Rope Ring Tie Down Strap

2" x 6" strap with universal fitting.

BPC-01080

Tie Off Ring

4000 Lbs. rating.

EM-19131

Zinc Plated Rope Ring

1/4" diameter steel ring and formed steel clamp.

800 Lbs. safe work load.

BPC-B20

Heavy Duty Recessed Rope Ring

Formed 1/8" steel pan houses a ductile iron ring.

3-5/8" diameter hole with 7/8" clearance below surface.

2000 Lbs. safe work load.

BPC-B801A



BPC-01080

EM-19131



BPC-B20



BPC-B50

Proportional brake controls deliver 100% of their full stopping power up to three times faster than timed controls. Proportional brake controls apply brakes to match pedal pressure. You get a smoother, more gradual, and more controlled stop. Maximize brake efficiency and minimize brake wear.

**Prodigy Brake Control (For 1, 2, 3, & 4 axle trailers)
BA-90185**

The most intelligent brake control is self-leveling and features new motion sensor technology. The only inertial control that works proportionally in reverse. (Great for backing into tough spots) Digital display depicts voltage delivery to trailer during braking. Exclusive “boost” feature gives users ability to apply more initial braking power when towing heavier trailers. Power-saving mode reduces drain on battery when vehicle is not in use. Pre-assembled wire harness for simple hookup.



**Primus Brake Control (For 1, 2, & 3 axle trailers)
BA-90155**

Utilizes the primary motion sensor of Prodigy and has a one step “Point and Go” set-up. Digital display depicts voltage delivery to trailer during braking. Snap-in-dash mounting clip & removable electrical connector allows unit to be quickly stored when not in use. Made for up to three-axel braking systems. Pre-assembled wire harness for simple hookup.



**Voyager Brake Control (For 1, 2, 3, & 4 axle trailers)
BA-9030**

Recessed controls protect gain and level settings from accidental readjustment. Traditional 4-wire hookup and under-dash U-bracket assures secure and permanent installation. System is compatible with virtually any 12-volt, negative ground tow vehicle. The green LED display tells you that the unit is on and there is a complete circuit with the trailer brakes. As braking power is applied, the LED changes color gradually.



**Envoy Brake Control (For 1 & 2 axle trailers)
BA-9040**

Equipped with inertia activated sensor that detects the tow vehicles rate of deceleration and applies proportional braking. New “Pivot-Mount” is ideal for installation in newer model tow vehicles. Easily adjustable to accommodate trailer weights. Green LED monitors a secure connection with trailer and changes to red to indicate increasing power to brakes. Simple 4-wire hookup.



O.E.M. Style wiring harness for models equipped with trailer tow package

Includes OEM connector, Prodigy/Primus connector, and 3 ft. leads.

* Please contact for a full vehicle application chart.

Vehicle Type	Model Years	Part No.
GM	2003-2005	BA-3015
	1999-2002	BA-3025
Ford	1994-2005	BA-3035
Ford Super Duty	2005	BA-3065
Dodge	1996-2005	BA-3020
Toyota	2002-2005	BA-3040
Nissan	2004-2005	BA-3050



7-Way Trailer Emulator

For use for the proper installation and set-up of a brake control when a trailer is not readily available.

Brake control set-up is accomplished using a built-in load module that will simulate electric magnet brakes on a trailer.

BA-6562



Breakaway Systems (Shur Set III)

For use on single, tandem, tri- and/or four axle trailers equipped with electric brakes. These complete systems incorporate the highest quality components in trailer breakaway systems. Meet or exceed D.O.T. specifications regarding trailer breakaway and holding requirements. If a breakaway occurs between your tow vehicle and your trailer, the breakaway systems will automatically apply consistent braking power to your trailer breaks. Quick and easy to install, the systems comes with weather resistant, heavy-duty polymer case to protect the battery and charger.

BA-2026 Includes:

Battery Case with A-frame or post mounting bracket (2018)

Rechargeable Sealed Battery (2023)

Nylon Breakaway Switch (2010)

BA-20005 Includes:

Lockable Battery Case with flat surface mounting (2051)

Rechargeable Sealed Battery (2023)

Nylon Breakaway Switch (2010)

BA-2028 Includes:

Battery Case with A-frame or post mounting bracket (2018)

Rechargeable Sealed Battery (2023)

DC to DC (Two-Stage) Battery Charger (2024)

Nylon Breakaway Switch (2010)

BA-2015 Includes:

Lockable Battery Case with flat surface mounting (2051)

Rechargeable Sealed Battery (2023)

DC to DC (Two-Stage) Battery Charger (2024)

Nylon Breakaway Switch (2010)



BA-2018



BA-2051



BA-2023



BA-2024



BA-2010

Breakaway System Accessories

Battery Case with A-Frame Bracket

Quick, easy one-bolt installation on jackpost or A-Frame. No need for cutting or drilling, U-shaped clamp mounts over most trailer tongues.

BA-2018



Battery Case for Surface Mount

Quick, easy four-bolt installation on any flat surface. For use with self tapping screws. Lockable case.

BA-2051



Breakaway Switches

Reinforced nylon case, weldable metal tab, nylon pull tab, and is rust and corrosion free.

BA-2010

BA-2010-A

Replacement Cable & Pin Assembly



Sealed Lead Acid Batteries

12 Volt sealed lead acid battery for use with Breakaway Systems on single, tandem, and tri-axle trailers.

BA-2023

5 Amp-hr Sealed Battery



DC to DC (Two-Stage) Battery Charger

Designed to fit securely into the Breakaway Batter Cases. Provides continuous recharge for all 12 Volt battery systems with 4 Amp-hr minimum output. Provides maintenance free assurance that breakaway batteries are always charged. Automatic shut-off feature will not permit overcharge.

BA-2024



AC to DC (Two-Stage) Battery Charger

For all 12 Volt battery systems with a 4 Amp-hr minimum output. Automatic shut-off feature that prevents overcharging. Ideal for seasonal storage and maintenance of recreational vehicles, and lawn tractors.

BA-2025



EL-Cor offers a complete line of Brake Control products and Accessories.

* Please call for a full line Tekonsha catalog, or to request more information.



Trailer Cable (Black Jacket)

Wire Gauge	Conductors	Colors	100 Ft. Spool	500 Ft. Spool
14 Gauge	4	Red, White, Black, & Brown	14-4TC-C	14-4TC-D
	6	Red, White, Black, Brown, Green, & Yellow	14-6TC-C	14-6TC-D
	7	Red, White, Black, Brown, Green, Yellow, & Blue	14-7TC-C	14-7TC-D
12 Gauge 10 Gauge	6 1	Red, White, Black, Brown, Green, Yellow, & Blue	12-7TC-C	12-7TC-D



ABS Trailer Cable (Green Jacket)

Wire Gauge	Conductors	Colors	100 Ft. Spool	500 Ft. Spool
12 Gauge	4	Black, Blue, Brown, Green, Red, Yellow, & White	12-7ABS-C	12-7ABS-D
10 Gauge	2			
8 Gauge	1			

7-Way Green ABS Coiled Cable Assembly

Includes heavy gauge wire used to power trailer and dolly ABS.
 Durable green outer jacket resists abrasion, provides excellent coil retention, and offers quick identification of ABS lines.
 Heavy-Duty zinc die cast plugs with spring guards included.
1/8, 2/10, 4/12 Gauge Cables.

- VEL-590160** 12 ft. Working Length, 12" Leads
- VEL-590161** 15 ft. Working Length, 12" Leads
- VEL-590163** 15 ft. Working Length, 40" Lead & 12" Lead



7-Way Coiled Cable Assembly

Durable black outer jacket resists abrasion, and provides excellent coil retention.
 Heavy-Duty zinc die cast plugs with spring guards included.
 Operating range of -55° to +185° F.

12 Foot Working Length with 12" Leads

- VEL-590154** 6/12, 1/10 Gauge Cables
- VEL-590156** 6/14, 1/12 Gauge Cables

15 Foot Working Length with 12" Leads

- VEL-590155** 6/12, 1/10 Gauge Cables
- VEL-590157** 6/14, 1/12 Gauge Cables



7-Way Straight Cable Assembly

Heavy-Duty zinc die cast plugs with spring guards included.
 ABS assemblies include heavy gauge wire used to power trailer and dolly ABS.
 ISO assemblies used in tractor/trailer systems requiring ISO 3731 style connectors.

Standard 7-Way Assemblies with 6/12, 1/10 Gauge Cables.

- VEL-590036** 8 ft. Working Length
- VEL-590046** 12 ft. Working Length
- VEL-590177** 10 ft. Working Length
- VEL-590178** 15 ft. Working Length

ABS 7-Way Assemblies with 1/8, 2/10, 4/12 Gauge Cables.

- VEL-590165** 12 ft. Working Length
- VEL-590166** 15 ft. Working Length

ISO 7-Way Assemblies with 1/8, 2/10, 4/12 Gauge Cables.

- VEL-590255** 12 ft. Working Length
- VEL-590256** 15 ft. Working Length



6-Way Coiled Cable Assembly

Durable black outer jacket resists abrasion, and has excellent coil retention.
 Heavy-Duty zinc die cast plugs with spring guards included.
6/14 Gauge Cables.

- VEL-590161** 12 ft. Working Length, 12" Leads



Two Pole Coiled Cable Assembly

Durable black polyethylene outer jacket resists abrasions and chemical damage while offering excellent coil retention. Heavy-Duty zinc die cast plugs with spring guards included. Rated at 200 amps for lift gate applications at 12 VDC. 4 gauge cable is internally grounded. Withstands temperatures of -85° to +185° F.



- VEL-590171** 12 ft. Working Length
- VEL-590172** 15 ft. Working Length

Single Pole Coiled Cable Assembly

Tailgate Lift Power Cable for applications that require direct electrical power to trailer lift gates. Blue jacketed 2 gauge cable. Rated at 265 amps intermittent service (30 seconds on / 50seconds off). Heavy-Duty zinc die cast plugs with spring guards included.



- VEL-590135** 12 ft. Working Length
- VEL-590136** 15 ft. Working Length

7-Way Plugs & Sockets

				
Plug Zinc Die Cast	Plug Glass Filled Nylon	Socket (Split Pin) Zinc Die Cast	Socket (Solid Pin) Zinc Die Cast	Socket (Solid Pin) Glass Filled Nylon
JP-11-702	JP-11-710	JP-11-721	JP-11-720	JP-11-723

* Cole Hersee and Velvac products available upon request.

7-Pole Sockets with Replaceable Circuit Breakers

Glass filled nylon nose box offers more durability and weight saving features.

Designed to provide easy serviceability of circuit breakers. Recommended that positive feed be attached to auxiliary post on circuit breaker. Will accept wide range of wire gauges from #14 wire to #8 ground wire. Replaces old style heavy weight metal boxes which can cause short circuits.

- JP-11-737** 20 Amp, Split Pin Socket
- JP-11-739** 30 Amp, Split Pin Socket
- CBS-20** 20 Amp Replacement Circuit Breaker
- CBS-30** 30 Amp Replacement Circuit Breaker





6-Way Plugs & Sockets

		
Plug (No Cable Guard) Zinc Die Cast	Plug (With Cable Guard) Zinc Die Cast	Socket (Concealed Terminals) Zinc Die Cast
JP-11-604	JP-11-605	JP-11-609

* Cole Hersee and Velvac products available upon request.

4-Way Plugs & Sockets

		
Plug (No Cable Guard) Zinc Die Cast	Plug (With Cable Guard) Zinc Die Cast	Socket (Concealed Terminals) Zinc Die Cast
JP-11-402	JP-11-403	JP-11-404

* Cole Hersee and Velvac products available upon request.





Single & Double Pole Plugs and Sockets

Single Pole Plugs & Sockets

Used to provide power to heavy draw auxiliary trailer equipment.
Heavy-Duty zinc die cast housing.
Power and ground terminals which hold up to 1/0 gauge wire.

Double Pole Plugs & Sockets

Heavy-Duty zinc die cast housing with internal ground.
200 amp with 4 gauge wire capacity

Single Pole		Double Pole	
			
Plug (With Cable Guard) Zinc Die Cast	Socket Zinc Die Cast	Plug (With Cable Guard) Zinc Die Cast	Socket Zinc Die Cast
VEL-591161	VEL-591113	VEL-593116	VEL-593121

* Cole Hersee and Velvac products available upon request.

Molded Inline Connectors

Molded Inline Connectors are used for connecting electrical systems. Wires are color coded for easy installation. Standard 18 gauge automotive wire is rated for 12 Volts, and 15 Amps. Polarized design to insure proper connection, molded case offers all-round weather protection. Connectors have 12" wire leads, except where noted.

* Cole Hersee and Velvac products available upon request.

Flat Type			Square Type	
2-Pole 18 Gauge Wire	4-Pole 18 Gauge Wire	4-Pole 48" Wire Leads (Female) 12" Wire Leads (Male)	6-Pole 18 Gauge Wire	6-Pole 48" Wire Leads (Female) 12" Wire Leads (Male)
JP-12-200	JP-12-403	JP-12-404	JP-12-600	JP-12-601



7-Pole RV Style Socket

Designed to be dependable in the harshest mounting environments. Made from high-impact nylon that solves corrosion problems and eliminates rusting when mated with special interlocking sealed connectors. Socket lid features stainless spring and runner gasket to guarantee against moisture when closed. Terminal pins are tin plated copper alloy providing higher conductivity and less resistance. Fits Ford style and universal Pollak mounting bracket (JP-12-711U) for other OEM applications

- JP-11-893** RV Socket (12V, 30 Amps)
- JP-12-711U** Mounting Bracket
- JP-11-998** Interlocking Mating Connector (Socket and 4 ft. Harness)
- JP-11-898P** RV Socket Kit



7-Pole Connectors

Plastic connector set eliminates rusting, poor appearance, and difficulty in plug removal. Design offers dual grips for ease of plug removal from socket and incorporates vinyl inserts to keep out dirt and moisture. Interior design prevents internal short-circuiting and the safety latch prevents damage from accidental pull-away. Color coded to RV1 standards.

- JP-12-706** Trailer-End Only Plug
- JP-12-707** Car-End Only Socket
- JP-12-711U** Mounting Bracket for Socket



RV Connector Adapters

6-Pole to 4-Pole	7-Pole to 4-Pole	7-Pole to 6-Pole Brake Pin in Center	7-Pole to 6-Pole Auxiliary Pin in Center
JP-12-717	JP-12-716	JP-12-719	JP-12-729

Heavy-Duty zinc die cast housing on part numbers 591009 and 591010.

Include solid brass pins and terminals with a spring clip to lock adapter and plug together.

Constructed of molded PVC for impact resistance on part numbers 591115, 591116, and 591117

Include solid brass pins and terminals with a spring clip to lock adapter and plug together.

				
7-Way Pin to 6-Way Adapter	6-Way Round to 7-Way Adapter	7-Way Blade to 4-Way Flat Adapter	7-Way Round to 4-Way Flat Adapter	6-Way Round to 4-Way Flat Adapter
VEL-591009	VEL-591010	VEL-591115	VEL-591116	VEL-591117

Molded Trailer End Connector and Cable

Plastic RV trailer connector molded to heavy duty trailer cable. Made with self-clearing contacts and molded to encapsulate terminals and wires to form one weather-tight assembly.

7-Way Molded Trailer End Connector & Cable

BA-5067001 6 Foot Cable Assembly

Primary wire gauges within the insulated cable are:

(10 Gauge Black & White) (12 Gauge Blue) (14 Gauge Brown, Red, Green, & Yellow)

6-Way Molded Trailer End Connector & Cable

BA-5061106 6 Foot Cable Assembly

Primary wire gauges within the insulated cable are:

(14 Gauge White, Blue, Brown, Red, Green, & Yellow)



Wiring Color Code Chart

Recreation Vehicle - 7 Pole Connectors			
No.	Color	Circuits	Wire Gauge
1	White	Ground Return	10 Ga.
2	Blue	Electric Brake	12 Ga.
3	Green	Tail, License, and Running Lights	14 Ga.
4	Black	Battery Charge	10 Ga.
5	Red	Stop & Left Hand Turn Signal	14 Ga.
6	Brown	Stop & Right Hand Turn Signal	14 Ga.
7	Yellow	Auxiliary Circuit	14 Ga.

Heavy Duty Truck - 7 Pole Connectors			
No.	Color	Circuits	Wire Gauge
1	White	Ground Return	8 Ga.
2	Black	Clearance, Sidemarker, & ID Lamps	12 Ga.
3	Yellow	Left Turn & Hazard Signal	12 Ga.
4	Red	Stop Lamps & Anti-Lock Devices	10 Ga.
5	Green	Right Turn Signal & Hazard Signal	12 Ga.
6	Brown	Tail, Rear, Marker, License Lamps	12 Ga.
7	Blue	Auxiliary Circuit / ABS	10 Ga.

Universal - 6 Pole Connectors			
No.	Color	Circuits	Wire Gauge
1	White	Ground Return	
2	Brown	Tail Lights	
3	Yellow	Left Turn	
4	Red	Stop	
5	Green	Right Turn	
6	Blue	Auxiliary Circuit	

Universal - 4 Pole Connectors			
No.	Color	Circuits	Wire Gauge
1	White	Ground Return	
2	Green	Right Turn & Brake Lights	
3	Yellow or Red	Left Turn & Brake Lights	
4	Brown	Tail Lights	

* Check all circuits before operating vehicles.

Push-Button Switches (Momentary)

Off-On, 35 Amp @ 12 VDC
 Normally off, on with button depressed.
 Two screw terminals

- CH-9095**
- CH-9216** O-Ring Seal
- CH-9245** O-Ring Seal & Rubber Cap



Off-On, 35 Amp @ 12 VDC
 Normally off, on with button depressed.
 Plastic button and screw-on cap
 Two screw terminals

- CH-90030**
- JP-24-360** Pollak Part No.



Off-On, 35 Amp @ 12 VDC
 Normally off, on with button depressed.
 Sealed with rubber cap.
 Two blade terminals.

- CH-90043**
- CH-90043-07** PVC Coated



Off-Mom On-On, 10 Amp @ 12 VDC
 On with button depressed, spring return to off.
 PVC coated body sealed against moisture and dirt.
 18 Ga. wire leads, fits panels up to 1/2".

- CH-M-608**



Engine Start-Engine Stop, 35 Amp @ 12 VDC
 Impact resistant molded plastic button with imprint.
 Repels oil, water, and other liquids.
 Die cast housing, with knurled aluminum facenut.

- CH-90047** Black Start Button
- CH-90048** Waterproof, Black Start Button
- CH-90047-01** Red Stop Button
- CH-90048-01** Waterproof, Red Stop Button



EL-Cor offers a complete line of Switches from Pollak and Cole Hersee.

- * Due to limited space, not all switches can be shown.
- * Please call for any full line catalogs, or to request more information.

Ignition Starter Switches (4-Position, Key Removeable in "Off" Position)

Base Type	Starter Lockout	Key Code	No. of Lip Seals	Mounting Pattern	Part No.
1	No	Various	0	2	JP-31-103
1	Yes	PK556	0	2	JP-31-106
1	No	Special	0	3	JP-31-159
1	No	Universal	1	4	JP-31-196
1	Yes	D250	2	5	JP-31-305
1	Yes		0	2	JP-31-608
1	Yes	Universal	1	4	JP-31-610
2	Yes	Universal	1	4	JP-31-242



Base Type 1

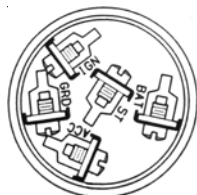

Base Type 2

Ignition Starter Switches (4-Position, Key Removeable in "Off" Position)

Base Type	Starter Lockout	Key Code	No. of Lip Seals	Mounting Pattern	Part No.
2	No	PK556	0	2	JP-31-112
3	No	D250	2	5	JP-31-229
3	Yes	Lever	0	1	JP-31-243
3	No	PK556	0	1	JP-31-249
3A	Yes	D250	1	5	JP-31-322
3A	Yes	D250	1	5	JP-31-231

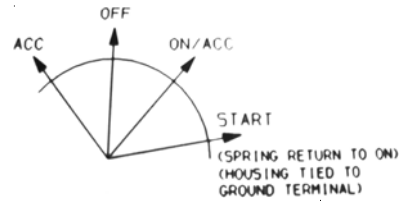

Base Type 2



Base Type 3



Base Type 3A

Ignition Starter Switches (3-Position, Key Removeable in "Off" Position)

Base Type	Starter Lockout	Key Code	No. of Lip Seals	Mounting Pattern	Part No.
1	No	C805	0	1	JP-31-122
1	No	D250	2	5	JP-31-245
4	No	Various	0	.75" D	JP-31-600
4	No	PK556	0	.75" D	JP-31-601

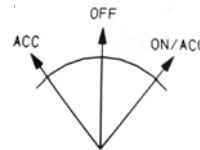

Base Type 1

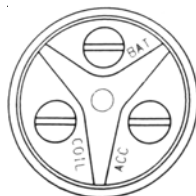

Base Type 4

Ignition Starter Switches (3-Position, Key Removeable in "Off" Position)

Base Type	Starter Lockout	Key Code	No. of Lip Seals	Mounting Pattern	Part No.
2	No	Universal	1	4	JP-31-345
3A	Yes	Universal	1	4	JP-31-297

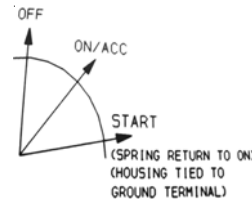

Base Type 2

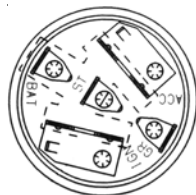

Base Type 3A

Replacement Keys

D250 Series

- JP-31-173-104, Blank Key Coined
- JP-31-173-102, Coined
- JP-31-355, Encapsulated with Logo
- JP-31-323, Encapsulated without Logo

Universal Key Series

- JP-31-166-001, Coined
- JP-31-332, Encapsulated with Logo
- JP-31-339, Encapsulated without Logo

PK Series

- JP-31-600-104, Blank Key Coined
- JP-31-600-103, Coined with Logo



Master Disconnect Switches are designed for 12 VDC vehicles to disconnect all circuitry to reduce possibility of theft and accidental electrical fires. Available in keyed or lever versions, with or without indexing pins.

* For a complete catalog featuring all available Battery Disconnect Switches, please contact for more information.

SPST Off-On, Lever Operated

180 Amps Continuous Capacity @ 6-36 Volts, 1000 Amps in rush.

For battery circuit only. Does not disconnect alternator or generator field circuit.

On vehicles equipped with alternators, engine must be shut off to avoid potential damage.

One-piece die-cast housing sealed with O-Rings at base and mounting stem to keep out dust and moisture.

Two 3/8" copper alloy stud terminals with hex nuts and lock washers.

Fits panels up to 1/4" thick.

JP-51-302

CH-2484-A Cole Hersee Part No.



Low Voltage Disconnect Switch

Electronic Low Voltage Disconnect Switch offers high output current capability. Automatically disconnects non-critical loads from a battery when the voltage falls below a pre-defined threshold. Automatically reconnects the loads to the starting battery when the battery is being charged. Automatically prevents loads from being disconnected during starting. An optional start signal override input is also provided.

- CH-48513** 100 Amps @ 12 Volt
- CH-48512** 150 Amps @ 12 Volt
- CH-48511** 150 Amps @ 24 Volt
- CH-48510** 200 Amps @ 12 Volt



Solenoid Switches

Typical applications include: Snow Plows, Truck Winch, Lift Trucks, and Low Voltage Equipment.

Intermittent and Continuous Duty Solenoids are available in Plated Steel, Phenolic Housings, PVC coated, and Plastic.

Copper ignition and ground terminals are #10-32 studs.

Contact terminals are 5/16"-24 thread.

Continuous Duty Solenoids

85 Amps

SPST Normally Open Contacts, One Circuit Off-On.

Bracket mounting holes are 5/16" x 19/32" on 2-13/64" centers.

Intermittent Duty Solenoids

750 Amps make, 100 Amp break, 10 sec On, 20 min Off

SPST Normally Off, One Circuit Off-On.

Bracket mounting holes are 5/16" x 19/32" on 2-13/64" centers.

Plastic Body Continuous Duty Solenoids

SPST Normally Open Contacts,

100 Amps make and break, 400 Amps inrush.

Bracket mounting holes are 5/16" x 19/32" on 2-13/64" centers.

Plastic Body Intermittent Duty Solenoids

SPST Normally Open Contacts,

200 Amps make and break, 5 Seconds On & 5 Seconds Off, 300 Amps inrush.

Bracket mounting holes are 5/16" x 19/32" on 2-13/64" centers.



Plated Steel Housing



Phenolic Housing



PVC Coated Housing



Plastic Body

* Please call for more product information, or to request a full line Cole Hersee catalog. *

Relays are a remote-control switch where electro-magnet forces operate the contacts in which main power current flows.

Normally Open Relay, SPST

A normally open relay closes an electrical circuit when current is passed through its coil.

Normally Closed Relay, SPST

A normally closed relay opens an electrical circuit or interrupts the flow of current. This type of relay is used to automatically disconnect head lights and radio when the engine is being started.

Change-Over Relay, SPDT

A change-over relay switches current from one user to another. Used for switching from forward to backward movement, from opening to closing electrically operated windows, and for two-stage users such as fans and some rear window heating systems.

*** Please call for more product information, including part numbers which are not shown, Pin Configurations, and Circuit Diagrams. Cross references are available.**

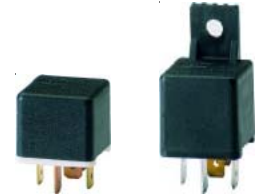

Type	Voltage	Amp Rating	Contact Form	Operating Voltage	Coil Resistance	Hella Part No.	Hella Marking No.	Bosch Part No.	Tyco Part No.
H.D. Potted w/ Bracket	12V	70A	SPST	8.5V	85	87110	4RA-003-437-04		V23134-J1052D642
Mini ISO w/ Bracket	24V	20A	SPST	17V	315	87111	4RA-003-510-09		VF4-41H11
Mini with Dual "87" Contacts	24V	20A	SPST	17V	315	87114	4RA-003-510-14	0332-019-213	VF4-199H11
Mini with Dual "87" Contacts & Bracket	12V	40A	SPST	8.5V	85	87453	4RA-940-010-67	0332-019-155	
Mini Skirted Bracket & Diode	24V	10/20A	SPDT	15V	320	87409	4RD-930-141-12		
Mini ISO	12V	40A	SPST	8.5V	86	87402	4RA-931-210-01		VF4-11F11
Mini ISO w/ Resistor	12V	20/40A	SPDT	8.5V	75	87404	4RD-960-388-02	0332-209-159	VF4-15F11-S01
Mini Skirted w/ Resistor	12V	20/40A	SPDT	8.5V	75	87408	4RD-960-388-06	0332-204-175	VF4-25F11-S01
Mini ISO	12V	20/40A	SPDT	8.5V	86	87401	4RD-960-388-08	0332-209-151	VF4-15F11
Mini ISO w/ Resistor -40° to +125° C	12V	20/40A	SPDT	8.5V	75	87423	4RD-960-388-10	0332-209-159	VF4-15F11-S01
Mini ISO Waterproof Bracket & Resistor	12V	20/40A	SPDT	8.5V	75	87411	4RD-960-388-15	0332-204-184	VF4-65F11-S01
Mini ISO w/ Bracket	12V	20/40A	SPDT	8.5V	86	87499	4RD-960-388-46	0332-209-150	VF4-45F11
Mini ISO Bracket & Resistor	12V	20/40A	SPDT	8.5V	75	87420	4RD-960-388-48	0332-209-161	VF4-45F11-S01
Mini ISO Bracket & Resistor	24V	10/20A	SPDT	15V	282	87426	4RD-960-388-49		VF4-45H11-S08
Mini ISO w/ Resistor	24V	10/20A	SPDT	15V	282	87115	4RD-960-388-50		VF4-15H11-S08
Mini ISO Waterproof Bracket & Resistor	24V	10/20A	SPDT	15V	282	87421	4RD-960-388-54		VF4-65H11-S08
Mini Skirted Bracket, Diode, & Resistor	12V	20/40A	SPDT	8.5V	81	87410	4RD-960-388-64		
Mini 280 Waterproof With Resistor	12V	20/40A	SPDT	8.5V	75	87406	4RD-931-410-05	0332-208-150	VF28-15F14-S01
Mini 280 Waterproof Bracket & Resistor	12V	20/40A	SPDT	8.5V	75	87417	4RD-931-410-08	0332-208-151	VF28-65F14-S01
Mini ISO w/ Bracket	12V	40A	SPST	8.5V	85	87106	4RA-003-510-08		VF4-41F11
Mini with Dual "87" Contacts & Bracket	12V	40A	SPST	8.5V	85	87118	4RA-003-510-26	0332-019-150	V23134-C1052-C642
Power Relay Bracket & Resistor	12V	70A	SPST	8.5V	100	87430	4RA-003-510-51	0332-019-110	VF7-41F11-S01-C01
Power Relay w/ Resistor	12V	70A	SPST	8.5V	100	87432	4RA-003-510-70		VF7-11F11-S01
Mini ISO w/ Diode	12V	20/40A	SPDT	8.5V	85	87424	4RD-003-520-25		
Mini ISO w/ Diode	24V	10/20A	SPDT	16V	315	87427	4RD-003-520-15	0332-209-204	
Micro w/ Resistor -40° to +135° C	12V	10/20A	SPDT	9V	81	87416	4RD-931-524-02	0332-207-307	VFM-15F21-S01
Mini ISO, High Capacity Potted w/ Resistor	12V	20/40A	SPDT	9V	76	87429	4RD-931-680-01		VF4-15F11-C01
Mini ISO w/ Bracket & Resistor -40° to +75° C	12V	20/40A	spdt	8.5V	75	87415	4RD-960-388-20	0332-209-167	

EL-Cor offers a complete line of Electro-Mechanical, Electronic, Loud Electro-Mechanical, Thermal, and Solid State Flashers. Please contact for more information, or technical specifications.



Type	Voltage	Power	Lamps	Terminals	Flashes Per Minute & Applications	Part No.
Electronic Flashers	11-15V	25A	1-12 Lamps	2	60-120	EF-32
	11-15	.10 to 25A	Self-Adjusting	2	For LED	EF-32RL
	11-15V	25A	1-12 Lamps	3	60-120	EF-33
	11-15V	.10 to 25A	Self-Adjusting	3	For LED	EF-33L
	12V	240W	1-10 Lamps	2	Car & Truck	EL-12
	12V	240W	1-10 Lamps	3	Car & Truck	EL-13
	24V	150W	1-6 Lamps	3	24 Volt Flasher	EG-23
	12V	25A	2-12 Lamps	2	70-120	VEL-091208
	12V	25A	2-12 Lamps	3	70-120	VEL-091209
	12V	35A	2-16 Lamps	2	70-120	VEL-091210
	12V	35A	2-16 Lamps	3	70-120	VEL-091211
	12V	45A	2-20 Lamps	2	70-120	VEL-091212
	12V	45A	2-20 Lamps	3	70-120	VEL-191213
	12V	162W	2 Turn 6 Hazard	4	Domestic Models	EP-26
	12V	162W	2 Turn 6 Hazard	5	Domestic Models	EP-27
	12V	100W	2 Turn 4 Hazard	3	GM 200 Style Flasher	EP-28
	12V	162W	3 Turn 6 Hazard	3	ISO Flasher Applications	EP35
	12V	150W	1-6 Lamps	3	Alternating Light Bars & Emergency Vehicles	EL-13A-1
	12V	160W	1-6 Lamps	3	Alternating Light Bars & Wig Wag Lights	EL-13A-2
	Electro-Mechanical Flashers	12V	240W	1-10 Lamps	2	Car & Truck
12V		240W	1-10 Lamps	3	Car & Truck	EL-13
24V		150W	1-6 Lamps	3	24 Volt Flasher	EG-23
Thermal Flashers	12V	100W	1-4 Lamps	3	Specialty Vehicles	FL-550
	12V	100W	1-4 Lamps	2	Vintage Vehicles	FL-552

EL-Cor offers a complete line of Miniature Bulbs. Most miniature bulbs come in standard boxes of 10. Please contact if you cannot find the correct bulb number that you require.

* 12 Volt to 24 Volt Bulb Chart

12 Volt	53L	57L	67L	89L	194L	1034L	1141L	1156L	1157L	1176L	1895L
24 Volt	356L	456L	1251L	623L	464L	1662L	307L	1683L	1662L	308L	1820L



Bulb Type	Base Type	Application	Voltage	Candle Power	Part No.
B-6	S.C. Bayonet	Auto/Interior	12	12.0	105L
	S.C. Bayonet	Auto/Interior	12	15.0	1003L
	D.C. Bayonet	Auto/Interior	12	15.0	1004L
B 3-1/2	S.C. Flanged	Flashlight, 2D	2.36	.80	PR2L
	S.C. Flanged	Flashlight, 3D	3.57	1.50	PR3L
	S.C. Flanged	Flashlight, 2C	2.33	.40	PR4L
	S.C. Flanged	Flashlight, 5D	5.95	3.10	PR12L
	S.C. Flanged	Flashlight, 6D	7.2	4.8	PR18L
	S.C. Flanged	Tool Light, Xenon	14.4	16.0	XPR14L
	S.C. Flanged		18.0	14.0	XPR18L
	G 3-1/2	Bi-Pin	Indicator	2.5	.50
Mini Bayonet		Indicator	7.5	1.0	51L
Mini Bayonet		Indicator	14	1.0	53L
Mini Bayonet		Indicator	14	.18	182L
Mini Bayonet		Indicator	28	.75	265L
Mini Bayonet		Aircraft	28	3.50	356L
Mini Bayonet		Auto	14	.70	1449L
Mini Bayonet		Indicator	24	.23	1450L
G 4-1/2	Mini Bayonet	Instrument	7.0	2.0	55L
	Mini Bayonet	Instrument	14	2.0	57L
	Mini Bayonet	Flasher	14	1.6	257L
	Mini Screw	Flasher	14	1.6	258L
	Mini Bayonet	Auto	14	2.0	293L
	Mini Bayonet	Indicator	6.5	1.9	455L
	Mini Bayonet	Instrument	28	2.0	456L
	Mini Bayonet	Marker	14	2.0	1895L
T 1-3/4	Mini Wedge	Auto	14	.50	37L
	Mini Wedge	Auto	14	1.5	70L
	Mini Wedge	Indicator	14	.30	73L
	Mini Wedge	Auto	14	.70	74L
	Mini Wedge	Indicator	28	.30	85L
	S.C. Flanged	Indicator	14	.30	382L
	S.C. Flanged	Indicator	14	.12	394L



EL-Cor offers a complete line of Miniature Bulbs, Sealed Beams, and Halogen Lamps.

* Please call for a complete Bulb Application Chart, or for more complete Bulb description and details.

* Please contact if you do not see the correct Bulb or Lamp for your application.

Bulb Type	Base Type	Application	Voltage	Candle Power	Part No.
 T 5-5/8	Wedge	Auto	13.5	4.0	904L
	Wedge	Auto	13.0	6.0	906L
	Wedge	Auto	12.8	12.0	912L
	Wedge	Auto	13.5	2.0	916L
	Wedge	Auto	12.8	21.0	921L



Halogen Bulbs

Bulb Type	Base Type	Application	Voltage	Candle Power	Part No.
 T 3-1/4	S.C. Bayonet	Halogen	12	108.0	795L
	G7.1	Halogen	12	108.0	979L
	Bi-Pin	Light Bars	12	24.0	1A27WL
	Bi-Pin	Light Bars	12	108.0	1A50WL
	P.C. Socket	Halogen	12	3.8	882L
	G4 Bi-Pin	Halogen	12	11.0	891L
	Axial	Halogen Fog	12	43.0	880L
	Rt. Angle	Halogen Fog	12	43.0	881L
	Axial	Halogen Fog	12	100.0	885L
	Rt. Angle	Halogen Fog	12	100.0	886L
	Axial	Halogen Fog	12	75.0	893L
	Rt. Angle	Auto Signal	12	43.0	889L
	Axial	Auto Signal	12	43.0	890L
	Rt. Angle	Tractro	12	75.0	894L

Bulb Type	Base Type	Application	Voltage	Candle Power	Part No.
OEM Repl.	P43T-38	Head Lamp	12	95/55	9003L
	Axial	Head Lamp	12	95/55	9004L
	Axial	Head Lamp	12	172/80	9004-100-55WL
	Axial	Head Lamp	12	136	9005L
	Axial	Head Lamp	12	80	9006L
	Rt. Angle	Low Beam	12	125	9006-80WL
	Axial	Head Lamp	12	107/80	9007L
	Axial	Head Lamp	12	172/125	90070-100-80WL
	Axial	H.I. Blue	12		9007HIBL



* Please call for a complete Bulb Application Chart, or for more complete Bulb description and details.

Halogen Bulbs

Bulb Type	Base Type	Application	Voltage	Watts	Part No.	Alternate Part No.
H1	P14.5S	Fog/Auxiliary	12	55	HE-78105	H1-55W-12VL
	P14.5S	Fog/Auxiliary	12	100	HE-78110	H1-100W-12VL
	P14.5S	Fog/Auxiliary	24	70	HE-78115	H1-70W-24VL
	P14.5S	Fog/Auxiliary	24	100	HE-78116	
H2	X511	Fog/Auxiliary	12	55	HE-78125	
	X511	Fog/Auxiliary	12	100	HE-78127	
	X511	Fog/Auxiliary	24	70	HE-78129	
H3	PK22S	Fog/Auxiliary	12	55	HE-78135	H3-55W-12VL
	PK22S	Fog/Auxiliary	12	100	HE-78140	H3-100W-12VL
	PK22S	Fog/Auxiliary	24	65	HE-78148	
	PK22S	Fog/Auxiliary	24	70	HE-78145	H3-70W-24VL
	PK22S	Fog/Auxiliary	24	100	HE-78132	
H4	P43T	Headlamp	12	60/55	HE-78155	H4-60/55W-12VL
	P43T	Headlamp	12	100/80	HE-78159	H4-100/80W-12VL
	P43T	Headlamp	24	75/70	HE-78160	H4-75/70W-24VL
	P43T	Headlamp	24	100	HE-78146	
H7	PX26D	Headlamp	12	55	HE-78175	H7-55W-12VL
	PX26D	Headlamp	12	70		H7-70W-12VL



Sealed Beam Lamps (Rectangular)

Bulb Type	Base Type	Application	Voltage	Watts	Part No.
Rectangular 92mm x 150mm	2 Rt. Angle Lugs	Halogen Auto/Fog	12	37.5	H9415L
	2 Rt. Angle Lugs	Halogen Auto/Fog, Amber	12	37.5	H9415AL
	2 Rt. Angle Lugs	Halogen Spot Lamp	12	50	H9405L
	2 Rt. Angle Lugs	Halogen Tractor Flood	12	50	H9406L
	2 Rt. Angle Lugs	Halogen Tractor Trapezoidal	12	50	H9411L
	2 Rt. Angle Lugs	Halogen Driving	12	50	H9420L
	2 Rt. Angle Lugs	Halogen Truck & Service	12	50	H9421L
	2 Lugs	Halogen Headlamp/Low Beam	12	55	H4703L
	2 Lugs	Halogen Headlamp/High Beam	12	65	H4701L
Rectangular 100mm x 165mm	2 Contact Lugs	High Beam	12	50	4651L
	2 Contact Lugs	Halogen High Beam	12	50	H4651L
	2 Contact Lugs	Halogen High Beam/Long Life	12	50	H4651LL
	2 Contact Lugs	Halogen High Beam	12	50	H5051L
	3 Contact Lugs	High/Low Beam	12	40/60	4652L
	3 Contact Lugs	Halogen High/Low Beam	12	35/35	H4656L
	3 Contact Lugs	Halogen High/Low Beam, LL	12	35/35	H4656LL
Rectangular 142mm x 200mm	3 Contact Lugs	High/Low Beam	12	65/55	6052L
	3 Contact Lugs	Halogen High/Low Beam	12	65/35	H6054L
	3 Contact Lugs	Halogen High/Low Beam, HO	12		H6054HOL



EL-Cor offers a complete line of Miniature Bulbs, Sealed Beams, and Halogen Lamps.

* Please call for a complete Bulb Application Chart, or for more complete Bulb description and details.

* Please contact if you do not see the correct Bulb or Lamp for your application.

Sealed Beam Lamps (Round)

Bulb Type	Base Type	Application	Voltage	Watts	Part No.
Par 36 4-1/2" Round	2 Screw	Flood Lamp	12	35	4406L
	2 Screw	Trapezoidal	12	35	4411L
	2 Screw	Signal	12	18	4414L
	2 Screw	Fog Lamp	12	35	4415L
	2 Screw	Fog Lamp/Amber	12	35	4415AL
	2 Screw	Spot Lamp	12	30	4416L
	2 Screw	Signal/Amber	12	30	4416AL
	2 Screw	Flood Lamp	12		4466L
	2 Screw	Headlamp	24		4502L
	2 Screw	Spot Lamp	24		4505L
	Multi-Purpose	Signal	12		7400L
Par 46 5-3/4" Round	2 Screw	Fog Lamp	12		4412L
	2 Screw	Fog Lamp/Amber	12		4412AL
	2 Screw	Flood Lamp	12		4413L
	Multi-Purpose	Spot Lamp	12		4436L
	2 Screw	Flood Lamp	24		4571L
	2 Contact Lugs	Flood Lamp	24		4578L
	2 Contact Lugs	Headlamp	12		5001L
	2 Screw	Halogen Spot Lamp	12		H7635L
Par 56 7" Round	3 Contact Lugs	Headlamp	12	60/50	6014L
	3 Contact Lugs	Headlamp	12	50/50	6015L
	3 Contact Lugs	Halogen Headlamp	12	65/35	H6024L
	3 Contact Lugs	Halogen Headlamp	12		H6024HOL







EL-Cor offers a complete line of Miniature Bulbs, Sealed Beams, and Halogen Lamps.

* Please call for a complete Bulb Application Chart, or for more complete Bulb description and details.
 * Please contact if you do not see the correct Bulb or Lamp for your application.

Pilot Lights (Incandescent)

Single Contact Pilot Lights

Corrosion resistant construction with spring-actuated brass contacts. 16 gauge insulated stranded copper wire is used for 8" leads. EL-Cor offers a full line of Pilot Lights and Indicator Lights from Cole Hersee, please call for a complete catalog.

				
Series	PL-20 Series with Ground Wire	PL-19 Series with Chrome Bezel	PL-85 Series with Faceted Lens	PL-86 Series with Large Lens
Type	Single Contact	Single Contact	Single Contact	Double Contact
Volts	12 Volt	12 Volt	12 Volt	12 Volt
Bulb Type	#53	#53	#67	#68
Lens Diameter	17/32"	17/32"	15/16"	15/16"
Mounting Stem Diameter	3/4"	3/4"	7/8"	7/8"
Amber	CH-PL-20-AC	CH-PL-19-AC	CH-PL-85-AC	CH-PL-86-AC
Blue	CH-PL-20-BC	CH-PL-19-BC	CH-PL-85-BC	CH-PL-86-BC
Green	CH-PL-20-GC	CH-PL-19-GC	CH-PL-85-GC	CH-PL-86-GC
Red	CH-PL-20-RC	CH-PL-19-RC	CH-PL-85-RC	CH-PL-86-RC

Sockets accept incandescent bulbs. 16 gauge insulated stranded copper wire with 8" leads, except where noted.
Single Contact Sockets accept BA15s base lamps: 63, 67, 81, 93, 97, 103, 209, 1073, 1129, 1133, 1141, 1156
Double Contact Sockets accept BA15d base lamps: 64, 68, 82, 88, 90, 210, 1004, 1076, 1130, 1142, 1158, 1176, 1178
Double Contact Indexed Sockets accept BA15z base lamps: 1154, 1157, 1157NA, 1534, 2057, 2057NA, 2357, 2357NA
Wedge Base: 158, 161, 168, 194, 194NA

Standard Base, Single Contact w/ Ground Wire

For back-up, tail, stop, turn, and cornering.
 Replaces: GMC 8909518, International 57121C91



CH-26145

Standard Base, Double Contact Indexed

For back-up, marker, park, turn, and cornering.
 Replaces: GMC 8919916, 12013813



CH-26152

Standard Base, Double Contact Indexed

For tail, stop, and turn.
 Replaces: Ford D0AZ, D1AZ, D20Z-13410B



CH-26146

Standard Base, Double Contact Indexed w/ Ground Wire

For tail, stop, park, and turn.
 Replaces: Chrysler 3588833, 3764123,
 Ford D4ZZ-13234A, D5VY-13410A, D3AZ-13410B



CH-26162

Wedge Base

For side marker, tail, cornering, and license plate.
 Replaces: Ford D0DZ-15A434B, D4Z-13410E,
 D5VY-15A442A, D7AZ, DD7FZ-13412A, E1FZ-13410A
 GMC 6294015, 6298886, 6298892, 6298935, 8918527,
 International 4189977C91



CH-25104

Snap-In Mounting w/ 8" Wire Lead

Accepts BA9 base bulbs: 51, 53, 356
 5/8" outside diameter.



CH-2505
 CH-2506

With Ground Wire

Sealed Beam Connectors

Accepts Sealed Beam headlamp connectors.
 Each connector has 14 gauge thermoplastic 8" wire leads.

Connector w/ 3 Wire Leads

CH-3029

Connector w/ 2 Wire Leads

CH-3051

Receptacle

Molded plastic connector.
 CH-3028-1 w/o Contacts
 CH-3028-02 w/ Contacts



Dimmer Switch Connectors

CH-30155
 Fits Cole Hersee 7762
 Ford 60-87, Dodge 59-86

CH-30156
 Fits Cole Hersee 7702, 7776
 Chevy 61-86, GMC 69-86
 International 61-80, Freightliner 63-67, 72-80,
 Kenworth 65-67, 72-74, 77-80



EL-Cor offers a complete line of Miniature Bulbs sockets, Sealed Beam connectors, and accessories.

* Please call for a complete Application Chart, or for more information.

* Please contact for a complete Cole Hersee catalog. EL-Cor may substitute parts with different manufacture unless specified.

EL-Cor offers a complete line of mirrors including West Coast, Blind Spot, Wide Angle, Universal, Light Duty Truck, Towing, and many more. Due to limited space not all products can be shown.

* Please call for a complete Velvac or Cham Cal Engineering catalog.

West Coast Mirrors

7" x 16" OEM V-Back Mirror

Over 96 sq. inches of viewing area.
Replaceable 1/8" FSC glass.
Round cornered housing with support bands.
5/16"-18 plated mounting hardware.

- VEL-708020** White
- VEL-708022** Stainless
- VEL-708046** Stainless Heated
- VEL-708001** Black (Silvered Glass)



7" x 16" OEM V-Back Mirror

Fits GM, Ford, Sterling, Mack, and International.
Full vinyl gasketed insulated mirror glass.
Includes adapters for International 4700-4900 series.
5/16"-18 stainless steel mounting studs.

- CCE-20601** Stainless Steel
- CCE-20603** Black
- CCE-20604** White



7" x 16" Flange Mount OEM Mirror

Fits International S-Series and other trucks.
Full vinyl gasketed insulated mirror glass.

- CCE-2000** Aluminum



Also Available:

- 7" x 16" Split Glass Mirrors
- 7" x 16" Ribbed Back Mirrors
- 6" x 16" West Coast Mirrors
- Motorized West Coast Mirrors
- Heated West Coast Mirrors
- Universal West Coast Mirror Assembly Kits
- Replacement Glass & Brackets

* Please call for complete catalog.

Convex Mirrors

8-1/2" Center Mount Mirror w/ "L" Bracket

13" radius of curvature glass.
5/16" adjustable female ball stud and bolt

- Velvac**
- VEL-708441** Stainless Steel
 - VEL-708442** Black

- Cham-Cal Engineering**
- CCE-10801** Stainless Steel
 - CCE-10803** Black



8-1/2" Offset Mount Mirror w/ "L" Bracket

13" radius of curvature glass.
5/16" adjustable female ball stud and bolt

- Velvac**
- VEL-708444** Stainless Steel
 - VEL-708446** Black

- Cham-Cal Engineering**
- CCE-12801** Stainless Steel
 - CCE-12803** Black



6" Center Mount Mirror w/ Bracket

14" radius of curvature glass.
5/16" adjustable female ball stud and bolt

- Velvac**
- VEL-708478** Stainless Steel
 - VEL-708479** Black

- Cham-Cal Engineering**
- CCE-10601** Stainless Steel
 - CCE-10603** Black



5" Center Mount Mirror w/ "L" Bracket

10" radius of curvature glass.
5/16" adjustable female ball stud and bolt

- Velvac**
- VEL-708470** Stainless Steel

- Cham-Cal Engineering**
- CCE-10501** Stainless Steel
 - CCE-10503** Black



Convex Mirrors (Stick-On)

Stick-On Convex Mirrors

Easily attaches to existing mirror to eliminate blind spot.
Corrosion resistant aluminum housing.
Adhesive back tape for quick installation included.

PM-V600	2" Round
CCE-10203 / PM-V603	3" Round
CCE-10303 / PM-V603L	3.75" Round
CCE-10403 / PM-602	4" x 5.5" Rectangular



Wide Angle System Mirrors

6-1/2" x 6" and 6-1/2" x 10" Side Mount Mirrors

Replaceable 1/8" glass on all mirrors, FSC on flat glass models and silvered glass with 21" radius on all convex models.
Outer gasket for edge shock protection, many available with heated or non-heated glass in steel or molded plastic finishes.
5/16"-18 mounting port on all mirrors.

* Please call for product details, or for a complete catalog.



Light & Medium Duty Mirrors and Assemblies

Available in general purpose mirror head replacement or for OEM replacement.

General purpose mirror heads come with a center mount 5/16" adjustable female ball stud, or with 4" elbow.
OEM replacement mirrors are available for the following:

- Chevrolet/GMC Full Size and Van Mirrors**
- Ford Truck and Van Mirrors**
- Dodge Trucks**

* Please call for product details, or for a complete catalog.



School Bus Mirrors

Mirrors designed for school bus applications include:

Convex Mirrors, Semi-Bubble Convex Mirrors, Full Bubble Convex Mirrors, and West Coast Mirrors,

* Please call for product details, or for a complete catalog.



EL-Cor Industries Inc.

www.elcorindustries.com

Phone (847) 465-7400 Fax (847) 465-9802



Located at the southeast corner of Palatine and Wolf Road. Across from the Chicago Executive Airport.

From Route 53

Head East on Palatine Road.

Exit Wolf Road.

Continue straight on Frontage Road. Crossing over Wolf Road.

Turn right at 15 East Palatine Road. (Between Wolf and Pinecrest Drive)

Our office door faces Palatine Road on the North side of the building.

From Milwaukee Ave.

Head West on Palatine Road.

Exit Wolf Road.

Turn left making a U-turn heading back East onto Frontage Road.

Turn right at 15 East Palatine Road. (Between Wolf and Pinecrest Drive)

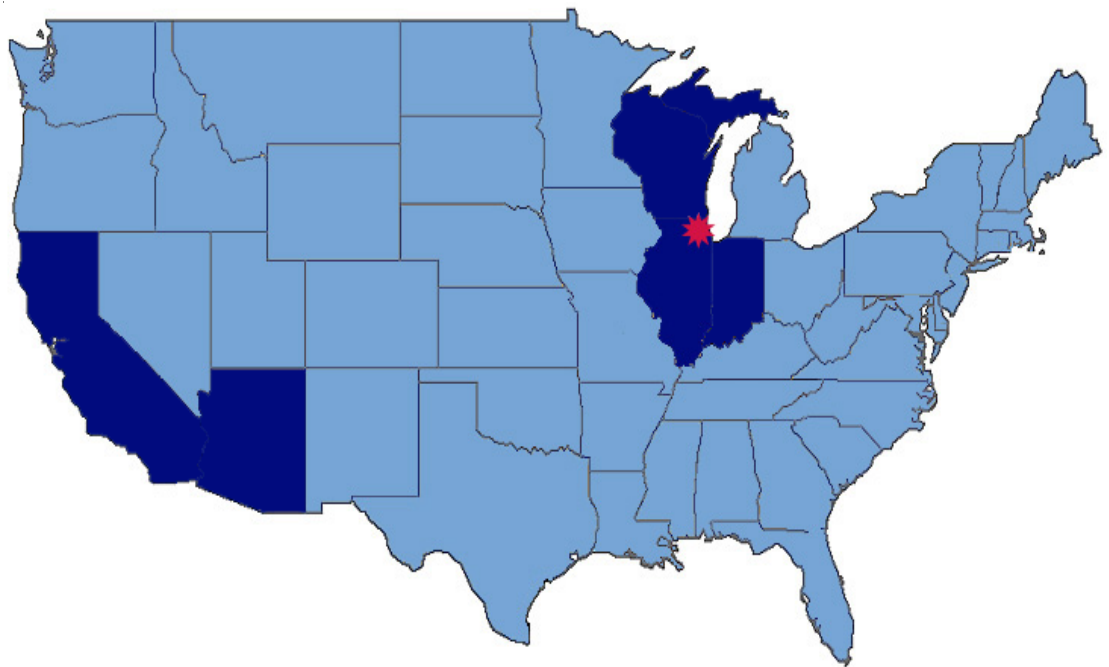

 Sales Representatives

 Inside Sales

 Main Office

Thank you for your interest in our company, we look forward to helping you.
Please call our toll free number for any questions, or to receive any product information.
Visit our website to view all of our current specials, and check out new product information.

Toll Free Number: **(888) 465-7400**
Website: www.elcorindustries.com

15 East Palatine Rd. Ste. 105 * Prospect Heights IL. 60070