

**LOCTITE®**

# LOCTITE® Aftermarket Products

Adhesives and Sealants Catalog – Volume 6

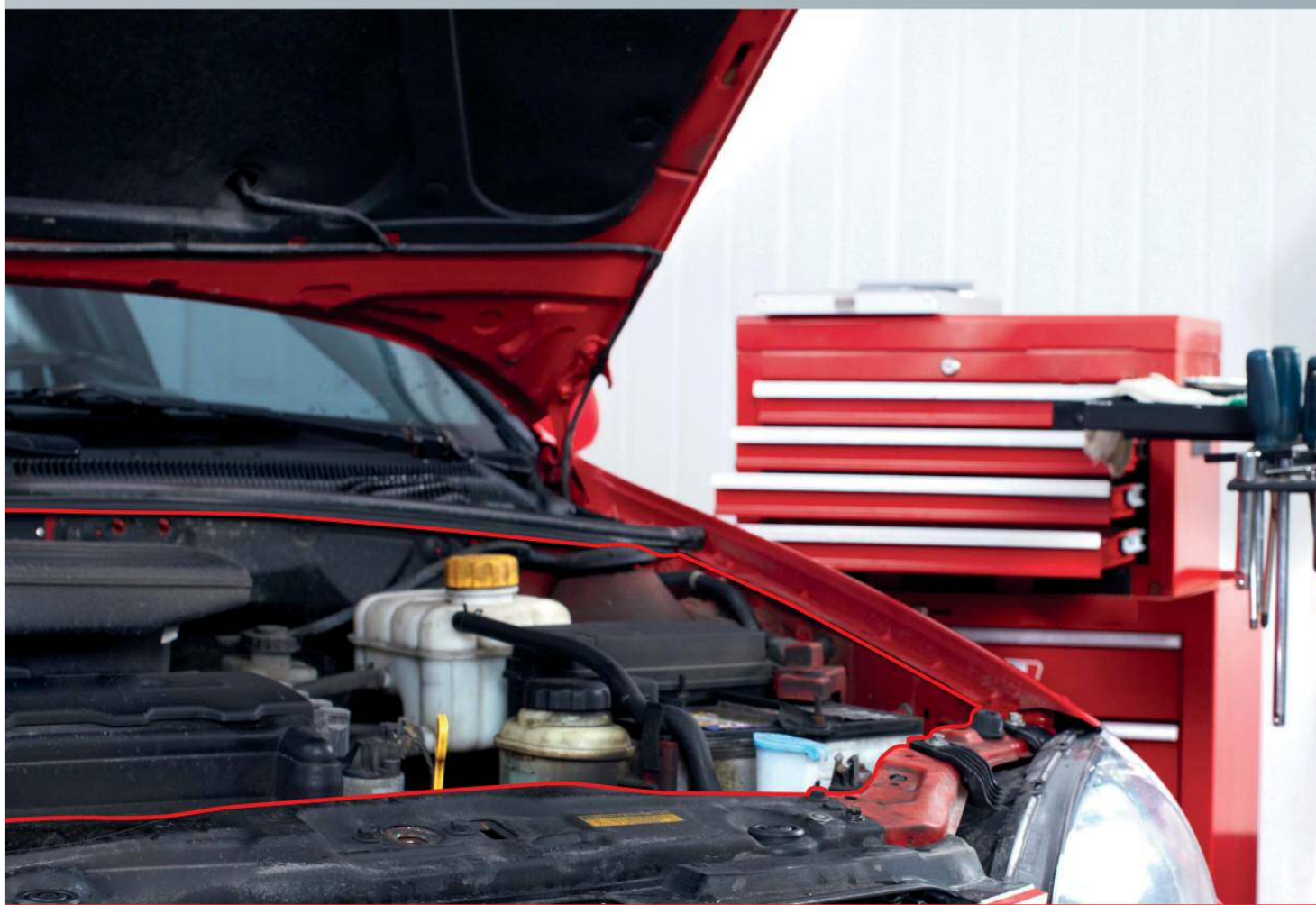

**Henkel** Excellence is our Passion





## PROFESSIONAL'S CHOICE

# Professional technicians choose LOCTITE® products.

Turn to Henkel for professional grade products you can count on. The same products used on race cars around the world. The same products automotive manufacturers use to build the cars you repair. Why use anything else?

At Henkel we manufacture and market more than just quality products, we provide repair solutions. When we develop a LOCTITE® Automotive Aftermarket product, our primary thought is this: "The professional mechanic can only afford to do a job once!" Our products must work properly the first time, every time.

LOCTITE® products have been reliably solving automotive maintenance and repair needs for over fifty years. Henkel invented the Threadlocking adhesive – a revolutionary method of positively locking and sealing threaded fasteners. When you buy our red bottles, you know you're getting an authentic LOCTITE® product! And since the beginning, Henkel has constantly added new products with new capabilities that provide solutions to your problems.

In this catalog, you'll find everything you need to know about LOCTITE® brand products for the Automotive Aftermarket and how they serve your application needs. The information is presented and grouped according to the product function (thread treatments, gasketing, adhesives, etc.) and includes product features, benefits, performance data, typical applications, selector guides, and package availability.

In addition to support from your local Henkel representative, this catalog is also supported by [henkelna.com/aam](http://henkelna.com/aam) – a virtual technical library designed to give you the best electronic support in the industry. Log on to the website to obtain additional technical information, such as material safety data sheets. To request product samples, application assistance, or the name of your nearest sales representative, call **1-800-LOCTITE (562-8483)**.



# Contents

LOCTITE® Sticks .....	4
Thread Treatments .....	6
Threadlockers .....	7
Thread Sealants .....	12
Retaining Compounds .....	14
Adhesives .....	16
Gasketing .....	20
Lubricants .....	28
Specialty Products .....	34
Product Application Guides .....	36-51
Automobile Engine .....	36
Diesel Engine .....	38
Heavy-Duty Differential/Axle .....	40
Automobile Transmission .....	42
Heavy-Duty Transmission .....	44
Heavy-Duty Suspension .....	46
Motorcycle Chassis .....	48
Motorcycle Engine .....	50
Marine Inboard Engine .....	52
Marine Outboard Engine .....	54
Agency Approval Listings .....	57
Product Index .....	58





# LOCTITE® STICKS

## No drips. No spills. No errors.

Henkel Corporation, the original inventor of anaerobic technology, now offers the same trusted performance in a solid stick formula. These patented stick products offer great flexibility for tough applications, especially overhead, and on components that cannot be moved. They're compact, making them easy to carry from job to job and easy to store in a toolbox, tool belt or pocket. The solid formula also means they won't spill or leak in toolboxes or on shop floors.



### LOCTITE® THREAD TREATMENT STICKS KIT

One of our most significant innovations – SOLID formula LOCTITE® Thread Treatment Sticks. Now conveniently packaged in a kit designed to give you all five products in one part number. Upside down, right side up, or any angle in between, these Sticks deliver!

Item	Container Size	Pack
38725	19–20 g sticks	5 Kits

#### KIT CONTAINS:

37700	LOCTITE® Red Stick Threadlocker (19 g)
37614	LOCTITE® Blue Stick Threadlocker (19 g)
37615	LOCTITE® Thread Sealant Stick (19 g)
37616	LOCTITE® Copper Anti-Seize Stick (20 g)
37617	LOCTITE® Silver Anti-Seize Stick (20 g)





## LOCTITE® STICKS

### LOCTITE® Blue Stick Threadlocker

Item Numbers 37614 / 37643  
(See page 7)



### LOCTITE® Red Stick Threadlocker

Item Numbers 37700 / 37701  
(See page 7)



### LOCTITE® Thread Sealant Stick

Item Number 37615  
(See page 12)



### LOCTITE® Silver Anti-Seize Stick

Item Number 37617  
(See page 29)



### LOCTITE® Copper Anti-Seize Stick

Item Number 37616  
(See page 29)



### LOCTITE® Hi-Tack Gasket Dressing Stick

Item Number 39158  
(See page 24)



### LOCTITE® Bearing Mount Stick

Item Number 39150  
(See page 15)



### LOCTITE® DISC BRAKE QUIET STICK

Item Number 40300  
(See page 30)



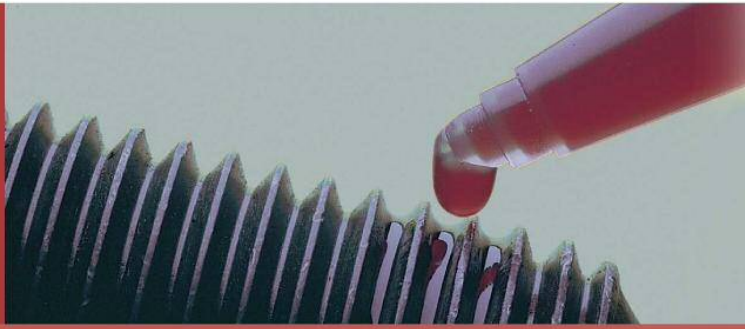

# THREAD TREATMENTS

## You can't lose.

Henkel offers a full line of thread treatment products to suit the needs of the professional mechanic. Prevent loose fasteners and equipment failure with a few drops of a LOCTITE® threadlocker; fill the inner voids in press fits with LOCTITE® retaining compounds; use LOCTITE® anaerobic pipe or thread sealants to prevent leakage in metal fittings caused by vibration loosening, tape shredding, solvent evaporation and temperature cycling; and seal plastic and metal fittings with LOCTITE® non-hardening pipe joint compound.



Invented by Henkel as a revolutionary method to positively lock and seal threaded fasteners, LOCTITE® threadlocker adhesives are used in a wide range of applications – from delicate fuel injection components to heavy-duty transmission and engine assemblies. Specified by automotive OEMs and approved for use on factory assembly lines, threadlockers work by filling the spaces between threads. The result is a secure, one-piece assembly that will not loosen under stress.

Available in varying strengths and temperatures, threadlockers perform reliably and effectively on fasteners of any type and size, either before or after assembly.

# THREADLOCKERS



## LOCTITE® BLUE STICK THREADLOCKER MEDIUM STRENGTH

This medium strength anaerobic threadlocker offers the same locking strength and sealing capabilities as our traditional blue threadlocking liquid, LOCTITE® Threadlocker 242®. This wax-like stick is conveniently packaged in a self-feeding stick applicator. It is well-suited for difficult repairs, as in overhead applications. It can be applied to a part even if assembly is to take place at a later time, making the stick ideal for volume assembly. Removable with hand tools.

**Typical Applications:** Valve cover bolts, water pump bolts, oil pan bolts, drive shaft bolts, rocker arm adjustment nuts, carburetor studs.

Item	Container Size	Pack
37643	9 g	10
37614	19 g	6



## LOCTITE® QUICKTAPE® 249™ BLUE THREADLOCKER TAPE MEDIUM STRENGTH

The one and only threadlocker in a tape form. This revolutionary product offers the same reliability and performance as LOCTITE® removable grade threadlocking liquids.

**Typical Applications:** Valve cover bolts, water pump bolts, oil pan bolts, drive shaft bolts, rocker arm adjustment nuts, carburetor studs.

Item	Container Size	Pack
1372603	260 in. roll	10



## LOCTITE® RED STICK THREADLOCKER HIGH STRENGTH

With the same convenient packaging as the medium strength LOCTITE® Blue Stick Threadlocker, this high strength threadlocker is better suited for heavy-duty applications where resistance to heavy shock, vibration and stress levels is required. Localized heating and hand tools are required to separate parts.

**Typical Applications:** Assembly with air tools, cylinder block bolts, ring gear bolts, transmission shaft bolts.

Item	Container Size	Pack
37701	9 g	10
37700	19 g	6



## LOCTITE® THREADLOCKER 222™ LOW STRENGTH

LOCTITE® Threadlocker 222™ is a low strength, purple threadlocker designed for fasteners under 1/4" (6 mm) that require occasional adjustment. Removable with hand tools for easy disassembly. Noncorrosive.

**Typical Applications:** Carburetors, relay locks, headlamps, throttle body assembly, choke assembly and fuel injection set screws, body panel mounting fasteners.

Item	Container Size	Pack
38653	6 ml tube	12





# THREADLOCKERS



## LOCTITE® THREADLOCKER 242® MEDIUM STRENGTH

LOCTITE® Threadlocker 242® is an all-purpose, medium strength, blue threadlocker. Ideal for all nut and bolt applications 1/4" to 3/4" (6 mm to 19 mm). Eliminates the need for stocking expensive lock nuts and lock washers. Locks and seals while preventing parts from loosening due to vibration. Protects threads from corrosion. Removable with hand tools for easy disassembly.



**Typical Applications:** Valve cover bolts, water pump bolts, oil pan bolts, drive shaft bolts, rocker arm adjustment nuts, carburetor studs.

Item	Container Size	Pack
24205	0.5 ml ampule	100
37418	6 ml tube	12
37477	36 ml bottle	6



## LOCTITE® THREADLOCKER 262™ HIGH STRENGTH

LOCTITE® Threadlocker 262™ is a permanent, high strength, red threadlocker that is applied to fasteners up to 3/4" (19 mm) in size before assembly. Designed for securing parts that must withstand heavy shock, vibration, or extreme chemical or environmental conditions. Localized heating and hand tools are required to separate parts.



**Typical Applications:** Assembly with air tools, cylinder block bolts, ring gear bolts, transmission shaft bolts.

Item	Container Size	Pack
37420	6 ml tube	12
37478	36 ml bottle	6



## LOCTITE® THREADLOCKER 243™ SURFACE INSENSITIVE

A general-purpose, medium strength, primerless, blue threadlocker with improved oil tolerance. For fasteners between 1/4" to 3/4" (6 mm to 20 mm). Parts can be separated using hand tools.



**Typical Applications:** Rocker studs, rocker adjustment bolts, bolts on valve and cam covers, oil pans, disc brake calipers, intakes and alternators, and pulley assemblies.

Item	Container Size	Pack
1330799	6 ml tube	6
1330906	36 ml bottle	6



## LOCTITE® THREADLOCKER 271™ HEAVY-DUTY

LOCTITE® Threadlocker 271™ is a high strength, red threadlocker for heavy-duty applications. Especially well-suited for permanently locking studs and press fits. Adds 3,000 psi holding power on slip and press fit assemblies. Replaces set screws and snap rings. Locks against vibration loosening. Removable with heat and hand tools. For fasteners up to 1" (25 mm) in size.



**Typical Applications:** Frame brackets, suspension fasteners, shock absorber mounts, wheel studs.

Item	Container Size	Pack
27105	0.5 ml ampule	100
37421	6 ml tube	12
37479	36 ml bottle	6



# THREADLOCKERS



## LOCTITE® THREADLOCKER 272™ HIGH TEMPERATURE

LOCTITE® Threadlocker 272™ withstands temperatures to 450°F. This high temperature/ high strength, red threadlocker is formulated for heavy-duty applications. Prevents bolts up to 1-1/2" (38 mm) from loosening due to shock, severe vibration and heat stress. Exclusive formulation for newer engines and high performance applications where extreme temperature resistance is required. Removable with heat and hand tools.

**Typical Applications:** Camshaft sprocket bolts, crankshaft bolts, idler bearings, press fit filler tubes, transmission input and output shaft threads, ring gear and shock bolts.

Item	Container Size	Pack
37480	36 ml bottle	6



## LOCTITE® THREADLOCKER 277™ HEAVY-DUTY/LARGE BOLTS

LOCTITE® Threadlocker 277™ is a high strength adhesive for locking and sealing large bolts and studs 1" (25 mm) or larger in diameter. Heat may be required to weaken bond before parts can be disassembled.

**Typical Applications:** Frame brackets, suspension fasteners, shock absorber mounts, wheel studs.

Item	Container Size	Pack
38656	36 ml bottle	6



## LOCTITE® THREADLOCKER 290™ PENETRATING

LOCTITE® Threadlocker 290™ is a low viscosity wicking grade, green, threadlocking liquid that wicks along the threads of pre-assembled fasteners to secure them in place. Since it is applied after assembly, preventive maintenance procedures are simplified. Ideal for fasteners ranging from #2 to 1/2" (2.2 mm to 12 mm) in size. Localized heating and hand tools are needed for disassembly.

**Typical Applications:** Bolts on alternators, air conditioning belts and distributor clamps, carburetor adjustment screws, and hairline cracks.

Item	Container Size	Pack
37423	6 ml tube	12
37481	36 ml bottle	6



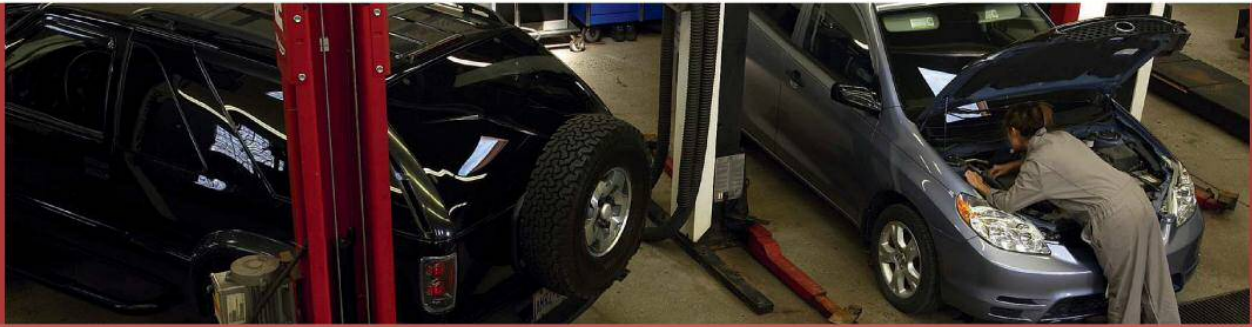

# THREADLOCKERS



## LOCTITE® KLEAN 'N PRIME™ ANAEROBIC ACTIVATOR

A solvent-based primer that features very long on-part life. Use to speed the cure of all LOCTITE® anaerobic products and ensure proper cure on inactive metals. Ideal for cure conditions below room temperature.



**Typical Applications:** All nut and bolt applications.

Item	Container Size	Pack
37509	4.5 oz. aerosol can	6



[henkelna.com/aam](http://henkelna.com/aam)

Visit us on the web for complete access to products, services, technical resources, and data sheets.

## When should I use a primer?

Use a primer when both surfaces are considered inactive. It is necessary to apply the primer to one surface, in most cases, unless gaps are excessive. See chart below.

ACTIVE METALS			
Iron	Plain Steel	Kovar™	Commercial Aluminum
Brass	Copper	Monel™	(with copper content e.g., 6061)
Bronze	Manganese	Nickel	
INACTIVE METALS			
Plated Parts	Pure Aluminum	Plastics	Natural or Chemical Black Oxide
Magnetite Steel	Titanium	Cadmium	Anodized Aluminum (Alodine®, Iridite™)
Stainless Steel	Magnesium	Inconel™	
Galvanized Steel	Gold and Silver	Zinc	

### Low Strength Threadlockers



- Removable with hand tools
- Adjustment screws
- Calibration screws
- Meters and gauges
- Up to 1/4" (6 mm) diameters

### Medium Strength Threadlockers



- Removable with hand tools
- Machine tools and presses
- Pumps and compressors
- Mounting bolts
- Gear boxes
- Up to 3/4" (19 mm) diameters

### High Strength Threadlockers



- Removable with heat and hand tools
- Heavy equipment
- Suspension bolts
- Motor and pump mounts
- Bearing cap bolts and studs
- Up to 1" (25 mm) and larger diameters

### Wicking Threadlockers



- Removable with heat and hand tools
- Preassembled fasteners
- Instrumentation screws
- Electrical connectors
- Carburetors
- Up to 1/2" (12 mm) diameters



# THREADLOCKERS

## Properties Chart: Threadlockers

LOCTITE® PRODUCT	Item Number	Container	Typical Use	Color	Viscosity (cP)	Torque in. lbs. (M10 Steel Nuts & Bolts) Break/Prevail	Temp. Range	Cure Speed, Steel @ 25°C	Oil Tolerant	Specific Gravity	Agency Approvals
<b>222™</b>	38653	6 ml tube	Low strength up to 1/4" (6 mm) screws	Purple	1,200/5,000 Thixotropic	53 / 30	-65°F - 300°F (-54°C - 149°C)	Fixture 10 min. — Full Cure 24 hrs.	•	1.05	•
<b>242®</b>	24205 37418 37477	0.5 ml ampule 6 ml tube 36 ml bottle	Removable grade up to 1/4" to 3/4" (6 mm to 19 mm) bolts	Blue	1,200/5,000 Thixotropic	110 / 43	-65°F - 300°F (-54°C - 149°C)	Fixture 10 min. — Full Cure 24 hrs.	•	1.07	Mil-Spec (S-46163A) Type II, Grade N, CFIA
<b>243™</b>	1330799 1330906	6 ml tube 36 ml bottle	1/4" to 3/4" (6 mm to 19 mm) bolts with light oil contamination	Blue	2,250/12,000 Thixotropic	180 / 62	-65°F - 360°F (-54°C - 182°C)	Fixture 5 min. — Full Cure 24 hrs.	Yes	1.08	Agriculture Canada approved
<b>249™</b>	1372603	260 in. roll	1/4" to 3/4" (6 mm to 19 mm) bolts, overhead, pre-dispensed, hard-to-reach areas	Blue	Tape	74 / 47	-65°F - 300°F (-54°C - 149°C)	Fixture 30 min. — Full Cure 24 hrs.	•	•	CFIA
<b>262™</b>	37420 37478	6 ml tube 36 ml bottle	High strength locking up to 3/4" (19 mm) bolts	Red	1,800/5,000 Thixotropic	189 / 275	-65°F - 300°F (-54°C - 149°C)	Fixture 5 min. — Full Cure 24 hrs.	•	1.05	Mil-Spec (S-46163A) Type II, Grade O, Agriculture Canada approved
<b>271™</b>	27105 37421 37479	0.5 ml ampule 6 ml tube 36 ml bottle	High strength for fasteners up to 1" (25 mm) diameter	Red	500	250 / 275	-65°F - 300°F (-54°C - 149°C)	Fixture 10 min. — Full Cure 24 hrs.	•	1.10	Mil-Spec (S-46163A) Type I, Grade K, UL classified, CFIA
<b>272™</b>	37480	36 ml bottle	High temperature applications	Red	9,500	200 / 220	-65°F - 450°F (-54°C - 232°C)	Fixture 30 min. — Full Cure 24 hrs.	•	1.11	CFIA
<b>277™</b>	38656	36 ml bottle	High strength for large bolts	Red	7,000	275 / 275	-65°F - 300°F (-54°C - 149°C)	Fixture 60 min. — Full Cure 24 hrs.	•	1.12	Mil-Spec (S-46163A) Type I, Grade L
<b>290™</b>	37423 37481	6 ml tube 36 ml bottle	Wicking grade for pre-assembled parts	Green	12	85 / 250	-65°F - 300°F (-54°C - 149°C)	Fixture 6 min. — Full Cure 24 hrs.	•	1.08	Mil-Spec (S-46163A) Type III, Grade R, CFIA
<b>Blue Stick Threadlocker</b>	37614 37643	19 g stick 9 g stick	Removable grade up to 1/4" to 3/4" (6 mm to 19 mm) bolts	Blue	Semisolid	110 / 43	-65°F - 300°F (-54°C - 149°C)	Fixture 10 min. (3 min. w/ primer) — Full Cure 24 hrs.	•	1.10	CFIA
<b>Red Stick Threadlocker</b>	37700 37701	19 g stick 9 g stick	High strength locking up to 3/4" (19 mm) bolts	Red	Semisolid	202 / 34	-65°F - 300°F (-54°C - 149°C)	Fixture 20 min. (5 min. w/ primer) — Full Cure 24 hrs.	•	1.06	CFIA

LOCTITE® thread sealants seal and secure metal pipes and fittings, filling the space between threaded metal parts. Thread sealants harden to prevent leakage caused by vibration loosening, tape shredding, solvent evaporation, damaged threads and temperature cycling. Designed for low and high pressure applications, thread sealants seal instantly for on-line low pressure testing. When fully cured, they seal to the burst strength of most piping systems.



# THREAD SEALANTS



## LOCTITE® THREAD SEALANT STICK HIGH PERFORMANCE

The LOCTITE® Thread Sealant Stick is a single-component, semisolid anaerobic pipe sealant compound. The self-feeding applicator stick facilitates application of the material where a conventional liquid or paste would be difficult to use. LOCTITE® Thread Sealant Stick cures rapidly to provide immediate low pressure sealing. The controlled lubricity prevents galling and protects mated threaded areas from rust and corrosion, and eases disassembly. Recommended for sealing metal tapered pipe threads and fittings in automotive applications.

**Typical Applications:** Stainless steel fittings, oil and coolant lines, fuel fittings, rear axle fill plug, intake manifold switches, head bolts into through holes, oil psi-sending units and sensors.

Item	Container Size	Pack
37615	19 g stick	6



## LOCTITE® 565™ THREAD SEALANT HIGH PERFORMANCE

This controlled strength sealant is formulated specifically for metal, tapered pipe thread fittings. LOCTITE® 565™ Thread Sealant replaces most tapes and pipe dopes. Cures rapidly to withstand 10,000 psi. Perfect as a replacement for pre-coated parts. Prevents galling and protects mated threaded areas from rust and corrosion.

**Typical Applications:** Stainless steel fittings, head bolts into through holes, oil psi-sending units/sensors, oil and coolant lines, intake manifold switches, rear axle fill plug, fuel fittings.

Item	Container Size	Pack
37396	50 ml tube	6



## LOCTITE® THREAD SEALANT 545™ PNEUMATIC/HYDRAULIC

LOCTITE® Thread Sealant 545™ is designed for locking and sealing high-pressure pneumatic and hydraulic systems. The pneumatic/ hydraulic sealant contains no fillers or particles that could contaminate system fluids, foul valves, or clog fine filters and screens. Reliably cures on "as received" fasteners. Controlled locking strength allows easy disassembly.

**Typical Applications:** Hydraulic line fittings, brake fittings, transmission fluid fittings, PTO fittings.

Item	Container Size	Pack
37482	36 ml bottle	6



## LOCTITE® 592™ THREAD SEALANT HIGH TEMPERATURE

LOCTITE® 592™ Thread Sealant locks and seals threaded fittings. Resists leakage, vibration loosening, moisture, hydraulic fluids, and diesel fuels. Lubricates threads for easy assembly and disassembly. Won't shred or wear like tape. Parts may be repositioned up to 24 hours after application. Works up to 400°F.

**Typical Applications:** Head bolts into through holes, oil psi-sending units and sensors, oil and coolant lines, fuel fittings, rear axle fill plug, brake and power steering fittings.

Item	Container Size	Pack
37398	6 ml tube	12
37397	50 ml tube	6



## THREAD SEALANTS



### LOCTITE® THREAD SEALANT WITH PTFE FITTING SEALANT

This economical, general-purpose fitting sealant outperforms tapes and pipe dopes. Seals and resists pressure in air, oil, and diesel fuel. Remains pliable at high and low temperatures. Temperature range: -65°F to 300° (-54°C to 149°C); resists common shop fluids.

**Typical Applications:** Air conditioning fittings, temperature sending fittings, hydraulic fittings.

Item	Container Size	Pack
1533652	16 oz. brushtop can	12



### LOCTITE® HEAD BOLT & WATER JACKET SEALANT

LOCTITE Headbolt & Water Jacket Sealant is a single-component anaerobic hybrid that lubricates fasteners during assembly, as well as seals the gaps between the threads. It eliminates corrosion, which can cause difficulties if future disassembly is required. The Head Bolt & Water Jacket Sealant locks the bolts in order to prevent premature loosening and, should the assembly need to be taken apart in the future, acts as a lubricant to ease the removal of fasteners that are through holes into water jackets.

**Typical Applications:** Headbolts, water pump bolts, thermostat housings, intake manifold bolts, temperature sensors.

Item	Container Size	Pack
1158514	50 ml tube	6

## Properties Chart: Thread Sealants

LOCTITE® PRODUCT	Part Number	Container	Typical Use	Color	Viscosity (cP)	Seal to Operating Pressure	Specific Gravity	Agency Approvals
Thread Sealant Stick	37615	19 g stick	General purpose	White	Semisolid paste	Seals operating pressures to 10,000 psi		UL Classified for U.S., ULC Classified for Canada, CSA International, CFA, NSF/ANSI 61
545™	37482	36 ml bottle	Pneumatic/hydraulic sealant, contains no fillers	Purple	14,000	Seals operating pressures to 10,000 psi	1.02	Agriculture Canada approved ABS
565™	37396	50 ml tube	Controlled strength	White	300,000	Seals operating pressures to 10,000 psi	1.10	CSA 3319-81, 3319-01 UL MH8007 (N) ULC-Canada approved Agriculture Canada approved
592™	37398 37397	6 ml tube 50 ml tube	Medium strength	White	350,000	Seals operating pressures to 10,000 psi	1.21	UL MH8007 (N) ULC-Canada approved Agriculture Canada approved
Head Bolt & Water Jacket Sealant	1158514	50 ml tube	General purpose fastener during assembly	Black	Paste	Seals operating pressures to 10,000 psi	N/A	N/A
Thread Sealant with PTFE	1533652	16 oz. brushtop can	General purpose, added lubricity	White	Paste	10,000 to 50,000 psi		

Use LOCTITE® Retaining Compounds to bond non-threaded, cylindrical metal assemblies. Fill the inner voids in close-fitting press fits, lock keyways and secure splines. Prevent wear and secure new parts, or restore fit to worn parts. Seal joints to stop leakage and prevent fretting and corrosion. Mount bearings and bushings, and make press fits and interference fits even stronger.

Formulated in a selection of viscosity, gap-filling ability, flexibility and strength characteristics, LOCTITE® Retaining Compounds can be used on all of your tough retaining applications.

# RETAINING COMPOUNDS



## LOCTITE® BEARING MOUNT 620™

HIGH TEMPERATURE

A high temperature (450°F/232°C), high viscosity liquid retaining compound. Provides a shear strength of over 3,800 psi on steel. Locks and secures metal cylindrical assemblies up to 0.015" (0.381 mm) diameter clearance. Prevents metal fretting and corrosion. Seals against leakage.

**Typical Applications:** Axle bearings, water and power steering pump pulleys.

Item	Container Size	Pack
38652	36 ml bottle	6



## LOCTITE® BEARING MOUNT 680™

RELAXED FITS

High strength, medium viscosity anaerobic adhesive for slip fit assemblies. Fixes in 10 minutes at room temperature.

**Typical Applications:** Replaces set screws, clamp rings, snap rings, wheel bearings, idler shaft, fit bearings.

Item	Container Size	Pack
37485	36 ml bottle	6



## LOCTITE® SLEEVE RETAINER 640™

HIGH STRENGTH

High temperature anaerobic adhesive that secures slip and press fit assemblies. Adds up to 3,000 psi holding power. Restores fit to worn or out-of-tolerance assemblies. Prevents surface corrosion. Works to 400°F (204°C).

**Typical Applications:** Cylinder sleeves, valve guides, valve seats, bearings and bushings, Woodruff keys, liner assemblies.

Item	Container Size	Pack
37424	6 ml tube	12
37484	36 ml bottle	6



## LOCTITE® PRESS FIT REPAIR 660™

FOR WORN PARTS

LOCTITE® Press Fit Repair 660™ is a creamy, non-running adhesive used to repair fit between parts. Also used to repair large gaps to 0.020" (.508 mm) in diameter and severely worn parts. Very rapid cure.

**Typical Applications:** Refitting worn shafts, housings, coupling and form-in-place shims, repairing worn keyways, loose set screws and other severely worn parts.

Item	Container Size	Pack
38651	50 ml tube	6





## RETAINING COMPOUNDS



### LOCTITE® BEARING MOUNT STICK HIGH TEMPERATURE

A revolutionary method to bond non-threaded, cylindrical metal assemblies, this unique wax-like stick works just like LOCTITE® Retaining Compound liquids to secure parts, seal joints and prevent corrosion. Replaces clamp rings, set screws and snap rings.

**Typical Applications:** Bushings, bearings, oil seals, ring gear bolts, differential lock pins, axle bearings, water and power steering pump pulleys.

Item	Container Size	Pack
39150	9 g stick	10



### Properties Chart: Retaining Compounds

LOCTITE® PRODUCT	Part Number	Container	Typical Use	Color	Maximum Gap Fill (Diametrical)	Viscosity (cP)	Shear Strength Steel/Steel (psi)*	Temperature Range	Cure Speed, Steel @ 25°C	Specific Gravity	Agency Approvals
620™	38652	36 ml bottle	High temperature and high strength	Green	0.015" (0.381 mm)	8,500	3,800	-65°F – 450°F (-54°C – 232°C)	Fixture 30 min. — Full Cure 24 hrs.	1.16	Agriculture Canada approved ABS
640™	37424 37484	6 ml tube 36 ml bottle	For high temperature applications	Green	0.007" (0.1778 mm)	600	3,000	-65°F – 400°F (-54°C – 204°C)	Fixture 1 hour — Full Cure 24 hrs.	1.12	Mil-Spec (R-46082B) Type II
660™	38651	50 ml tube	For repair of worn machinery parts	Silver	0.020" (0.508 mm)	250,000/ 1,500,000 Thixotropic	3,335	-65°F – 300°F (-54°C – 149°C)	Fixture 20 min. — Full Cure 24 hrs.	1.13	Agriculture Canada approved
680™	37485	36 ml bottle	High strength for slip fitted parts	Green	0.015" (0.381 mm)	1,250	2,800 (minimum)	-65°F – 300°F (-54°C – 149°C)	Fixture 10 min. — Full Cure 24 hrs.	1.11	ABS
Bearing Mount Stick	39150	9 g stick	General purpose, high temperature	Green	0.005" (0.127 mm)	Semi-solid	3,800	-65°F – 400°F (-54°C – 204°C)	Fixture 30 min. — Full Cure 24 hrs.	1.1228	•

\*Varies with substrates.

As an adhesive innovator, Henkel offers a range of quality liquids, pastes, aerosols, putties and gels, each specifically designed to meet any number of automotive applications. From bonding auto trim, to sealing weatherstripping, to repairing broken grilles, there's a LOCTITE® adhesive or sealant for all of your repair needs.



# ADHESIVES



## LOCTITE® REARVIEW MIRROR ADHESIVE PERMANENT

Approved and used by GM, Ford and Chrysler. Permanently remounts mirrors to windshields. Achieves handling strength in seconds; mirror-mounting strength in 15 minutes. Available in single and multi-application size packaging.



**Typical Applications:** Mounting rearview mirrors to windshields.

Item	Container Size	Pack
37438	0.3 cc kit	12
03346	6 ml kit	12
03325	24 ml kit	5



## LOCTITE® EPOXY QUICK SET™ ADHESIVE

Fast curing, non-shrinking, colorless epoxy in convenient, two-part dispensing syringe. Bonds most rigid materials. Resists most solvents. Versatile and shock resistant.

**Typical Applications:** Auto trim, ornaments, tools, emblems, knobs.

Item	Container Size	Pack
1395391	0.85 fl. oz. syringe	8



## LOCTITE® REAR WINDOW DEFOGGER TAB ADHESIVE

Quickly and easily bonds defogger tab to grid on rear window. Provides a low-cost, high-quality repair for damaged rear window defogger tabs. Complete kit for a quick repair.

**Typical Applications:** Rear window defogger tabs.

Item	Container Size	Pack
21351	0.03/0.02 fl. oz.	6



## LOCTITE® EPOXY PLASTIC BONDER ADHESIVE

Acrylic formula, specially formulated to bond and repair plastic surfaces. When mixed in equal volumes, the components react to produce a tough, rigid, high strength bond in 20 to 25 minutes. Can be sanded and drilled.

**Typical Applications:** Bonding substrates such as: PVC, polycarbonate, acrylic, ABS, FRP, nylon, Mylar®, Delrin®, phenolic, aluminum and stainless steel.

Item	Container Size	Pack
1363118	0.85 fl. oz. tube	8



## LOCTITE® WINDSHIELD REPAIR KIT ONE-COMPONENT SYSTEM

A one-component windshield repair system designed to be used by the car owner. Requires no mixing, no heat. Safe and easy to use. Has the same index of refraction as the original glass to make the repair virtually undetectable.

**Typical Applications:** "Bullseyes" in windshields or other laminated glass windows.

Item	Container Size	Pack
37613	0.17 fl. oz. syringe	12



## LOCTITE® 3092™ ADHESIVE KIT

Ultra-fast gel adhesive that can bond gaps up to 2 mm in depth. Excellent for general repairs. Virtually eliminates blooming or frosting. Includes three mix nozzles.

**Typical Applications:** Interior molding clips, consoles, dash components, molded bumpers, body, trim repair.

Item	Container Size	Pack
1807961	10 g syringe	12

## LOCTITE® CA MIX NOZZLE, (5) PACK

Extra mix nozzles for LOCTITE® 3092™ Adhesive Kit. One package includes 5 mix nozzles.

Item	Container Size	Pack
1434516	5 nozzles	1



# ADHESIVES



## LOCTITE® SUPER GLUE PROFESSIONAL INSTANT ADHESIVE

Proven superior performance over ordinary super glues. It dries clear and sets without clamping. It's resistant to moisture, most chemicals and freezing temperatures.

**Typical Applications:** Ideal for heavy-duty projects and repairs. Repairing figurines, costume jewelry, cameras, toys, metal car parts, wiper blades, rubber seals and O-rings.

Item	Container Size	Pack
1365882	20 g bottle	4



## LOCTITE® SUPER GLUE LIQUID INSTANT ADHESIVE

Super strong, super fast adhesive bonds materials in seconds, including rubber, metal, plastic, glass and vinyl. Makes repairs to almost all non-porous surfaces.

**Typical Applications:** Metal, laminated plastics, rubber, ceramics, china.

Item	Container Size	Pack
1399967	2 g tube	12



## LOCTITE® SUPER GLUE LONGNECK BOTTLE INSTANT ADHESIVE

Features a precision tip that allows controlled application without dripping. The long nozzle is ideal for gluing hard-to-reach surfaces.

**Typical Applications:** Bonds ceramic, rubber, paper, metal, china, wood and most plastics

Item	Container Size	Pack
230992	5 g bottle	6



## LOCTITE® SUPER GLUE ULTRA GEL CONTROL INSTANT ADHESIVE

Specially formulated, rubber-toughened instant adhesive that resists impact, shock, vibration and temperature extremes. Ideal for bonds subject to daily use and harsh conditions. Dries clear and is resistant to moisture and freezing temperatures.

**Typical Applications:** Bonding leather, cork, paper, cardboard, wood, chipboard, fabric, metal, ceramic, rubber, hard plastics, polycarbonate, polystyrene and PVC.

Item	Container Size	Pack
1363589	4 g applicator	6



## LOCTITE® SUPER GLUE ULTRA LIQUID CONTROL INSTANT ADHESIVE

The liquid formula works well on a variety of porous and non-porous surfaces. Comes in a patented side-squeeze design for maximum control. It dries clear and sets without clamping. Resistant to moisture, most chemicals and freezing temperatures.

**Typical Applications:** Repairing figurines, costume jewelry, cameras, toys, metal car parts, wiper blades, rubber seals and O-rings.

Item	Container Size	Pack
1647358	4 g applicator	6



## LOCTITE® QUICK GEL® SUPER GLUE INSTANT ADHESIVE

This gel formula super glue was designed for fast, heavy-duty repairs to vertical surfaces, where regular adhesive runs. Works on porous and non-porous materials.



**Typical Applications:** Metal, most plastics, laminated plastics, vinyl, rubber, ceramics, paper, wood, textiles, leather, synthetic leather, cork, and chipboard.

Item	Container Size	Pack
37391	2 g tube	12



# ADHESIVES



### LOCTITE® QUICKTITE® SUPER GLUE GEL INSTANT ADHESIVE

With the same superior performance as the liquid version, the no-run gel formula stays put for no-mess and precise application, even on vertical surfaces. The gel formula works on porous and non-porous materials.

**Typical Applications:** Metal, most plastics, rubber, vinyl, paper, wood, textiles, ceramics, china and cork.

Item	Container Size	Pack
39123	4 g applicator	6



### LOCTITE® RTV BLACK SILICONE ADHESIVE/SEALANT

General-purpose, black RTV indoor/outdoor sealant. Seals, bonds, repairs, mends and secures glass, metal, plastics, fabric, vinyl, weatherstripping and vinyl tops. Protects and repairs electrical wiring. May be applied to horizontal or vertical surfaces. Waterproof and flexible. Temperature range: -80°F to 450°F (-62°C to 232°C); resists oil, water, weather, vibration, grease.

**Typical Applications:** Windshields, door frames, electrical connections, seams and roofs, vinyl tops, weatherstripping.

Item	Container Size	Pack
37460	80 ml tube	12
40464	190 ml power can aerosol	6
37523	300 ml cartridge	10



### LOCTITE® RTV CLEAR SILICONE ADHESIVE/SEALANT

General-purpose, clear RTV indoor/outdoor sealant. Seals, bonds, repairs, mends and secures glass, metal, plastics, fabric, vinyl, weatherstripping, and vinyl tops. Protects and repairs electrical wiring. May be applied to horizontal or vertical surfaces. Waterproof and flexible. Temperature range: -80°F to 450°F (-62°C to 232°C); resists oil, water, weather, vibration, grease.

**Typical Applications:** Windshields, door frames, electrical connections, vinyl tops, seams and roofs.

Item	Container Size	Pack
37463	80 ml tube	12
40481	190 ml power can aerosol	6
37521	300 ml cartridge	10



### LOCTITE® EPOXY MIXER CUPS FAST CURE

Convenient pre-measured epoxy mixer cups. No mess, no guess, no waste. Ideal for bonding glass, hard plastics, rubber, and metal. Bonds in 5 to 15 minutes. Grey adhesive has excellent chemical resistance. Fills porosities and can be used to build up worn parts.

**Typical Applications:** Loose trim, broken grilles, loose door glass channels, casting cracks and holes.

Item	Container Size	Pack
37513	10–0.12 oz. cups	10
39089	4–0.12 oz. cups	6



### LOCTITE® LOCWELD™ BONDING COMPOUND COLD WELD

A 15-minute, two-part adhesive and filler system that eliminates the need for welding or brazing. Once cured, it can be drilled, sanded, painted or filed. Resists most automotive, shop and cleaning fluids. Withstands temperatures to 300°F intermittent. Over 3,000 psi shear strength on steel.

**Typical Applications:** Aluminum, steel, brass, bronze, castings and stampings.

Item	Container Size	Pack
37531	2 pk. – 1 oz. tubes	12





# ADHESIVES



## LOCTITE® STIK 'N SEAL® EXTREME CONDITIONS CONTACT ADHESIVE

Contains the revolutionary new Flextec® formulation, which bonds more surfaces faster than ordinary household adhesives. It is a versatile, heat-resistant adhesive that bonds, seals and repairs most materials.

**Typical Applications:** Ideal for bonds subject to harsh or extreme conditions or for situations where constant flexing is a problem. Indoor/outdoor use, excellent adhesion, high initial grab, cures quickly.

Item	Container Size	Pack
1360784	0.58 fl. oz. tube	6



## LOCTITE® ALL PURPOSE SPRAY ADHESIVE

Bonds lightweight, porous and non-porous surfaces. Allows repositionable and permanent bonds. Dries clear and fast; won't shrink or bleed. Resists water and humidity.

**Typical Applications:** Attaching upholstery cloth, carpeting, floor mats, insulation, kick and silencer pads to metal, wood or KB board.

Item	Container Size	Pack
30544	10.5 oz. aerosol can	12



## LOCTITE® SPRAY ADHESIVE PROFESSIONAL PERFORMANCE

LOCTITE® Spray Adhesive Professional Performance is a premium quality formulation that creates high strength and high-temperature-resistant permanent bonds. It dries clear and is non-yellowing. For light and demanding applications. Can be used indoors and outdoors.

**Typical Applications:** Decorative laminate/trim work, marine applications, upholstery work, carpet, van/motor home conversions, kick plates and signage. Ideal where support is not possible.

Item	Container Size	Pack
1629134	13.5 oz. aerosol can	6



## LOCTITE® POWER GRAB® ALL-PURPOSE CLEAR CONSTRUCTION ADHESIVE

Single-component adhesive for interior and exterior repairs or building projects. Holds instantly, eliminating the need for bracing and nailing.

**Typical Applications:** Bonds to most construction materials, such as metal, ceramic, wood, concrete and most plastics. One surface must be porous.

Item	Container Size	Pack
1804373	300 ml cartridge	12



## LOCTITE® BLACK WEATHERSTRIP ADHESIVE FAST DRYING

A professional, black weatherstrip adhesive that blends with automotive weatherstripping for less cleanup. Withstands temperature extremes. Resistant to gasoline, kerosene, antifreeze, and most solvents. Permanently bonds automotive weatherstripping. Bonds automotive gaskets. A superior adhesive for bonding a variety of common materials.

**Typical Applications:** Cut gaskets, auto or van carpeting, door and trunk moldings, vinyl tops, fabric-backed vinyl upholstery, headliners.

Item	Container Size	Pack
37532	5 fl. oz. tube	12



## LOCTITE® YELLOW WEATHERSTRIP ADHESIVE FAST DRYING

A fast drying, high strength, waterproof adhesive that closely color-matches original equipment materials. Professional strength bonds all types of weatherstripping materials and sunroof moldings. Resistant to oils, water and grease.

**Typical Applications:** Auto or van carpeting, all types of weatherstripping, door and trunk moldings.

Item	Container Size	Pack
40669	5 fl. oz. tube	12



# GASKETING

## Any gasket shape, any time.

Henkel's innovative LOCTITE® gasketing products offer precise, reliable sealing. These gasketing materials include products with excellent fluid resistance and formulations for high operating temperatures, high torque retention and sensor-safe characteristics. A leader in form-in-place gasket makers, gasket dressings and general-purpose sealants, Henkel offers a choice of LOCTITE® anaerobic, RTV silicone or solvent-based products to meet a broad range of complex automotive gasketing and sealing needs.





# GASKETING

## Easy Dispense Power Can Aerosols

- More accurate dispensing of constant, steady silicone beads
- Ergonomic and easy-to-use fingertip trigger
- Silicone product and dispense system in one, eliminating the need for a caulking gun
- Attached nozzles – no more searching for displaced nozzles
- Nonflammable products
- Propellants used are V.O.C.-free



### LOCTITE® POWER CAN DISPLAY RACK

UNIQUE POWER CAN DISPLAY WILL HELP YOU OPTIMIZE YOUR SALES OF LOCTITE® SILICONE POWER CANS!

Display is 16 1/2" tall x 16" wide x 6 3/4" deep. It can sit on a countertop or be hung on a pegboard.

Merchandise all eight items of the LOCTITE® Silicone Power Cans. Each hook holds three power cans.

Item	Container Size	Pack
1027663	16 1/2" x 16" x 6 3/4"	1



# GASKETING



## LOCTITE® RTV 587™ BLUE SILICONE GASKET MAKER HIGH PERFORMANCE

Forms tough, flexible gaskets directly on the flange. Sensor-safe, low odor, noncorrosive. Excellent oil resistance and joint movement values. Eight times more flexible than cork/composite gaskets; three times more oil-resistant than conventional silicones. Temperature range: -75°F to 500°F (-59°C to 260°C) intermittent; resists auto and shop fluids.

**Typical Applications:** Valve covers, oil pans, timing covers, transmission pans, differential covers.

Item	Container Size	Pack
37465	80 ml tube	12
40462	190 power can aerosol	6
37516	300 ml cartridge	10



## LOCTITE® RTV 598™ BLACK SILICONE GASKET MAKER HIGH PERFORMANCE

For dealership warranty requirements, ensures extended drivetrain warranty compliance. Fast-curing formula. Sensor-safe, low odor, noncorrosive. Meets performance specs of OE silicone gaskets. Retains high flexibility, oil resistance properties. Temperature range: -75°F to 625°F (-59°C to 329°C) intermittent; resists auto and shop fluids and vibration.

**Typical Applications:** Valve covers, oil pans, intake manifold end seals, timing covers, transmission pans.

Item	Container Size	Pack
37472	0.37 oz. tube	6
37467	80 ml tube	12
40463	190 ml power can aerosol	6
37519	8.75 oz. pressurized can	6
37518	300 ml cartridge	10



## LOCTITE® RTV 5699™ GREY SILICONE GASKET MAKER HIGH PERFORMANCE

Designed for high torque applications. Exceeds manufacturers' performance requirements. Remains flexible and withstands high vibration. Low odor. Non-corrosive. Outstanding oil resistance. Temperature range: -75°F to 625°F (-59°C to 329°F) intermittent; resists auto and shop fluids.

**Typical Applications:** Valve covers, oil pans, intake manifold end seals, timing covers, water pumps, thermostat housings.

Item	Container Size	Pack
37464	80 ml tube	12
40505	190 ml power can aerosol	6



## LOCTITE® RTV 5920™ COPPER SILICONE GASKET MAKER HIGH PERFORMANCE

Premium silicone for 4-cylinder, turbocharged or high-performance engines. Sensor-safe, low odor, non-corrosive, low volatility, non-conductive. Superior adhesion and oil resistance. Temperature range: -75°F to 700°F (-59°C to 371°C) intermittent; resists auto and shop fluids and vibration.

**Typical Applications:** Valve covers, oil pans, timing covers, water pumps and thermostat housings.

Item	Container Size	Pack
37466	80 ml tube	12





# GASKETING



## LOCTITE® RTV BLUE SILICONE GASKET MAKER SENSOR SAFE

Replaces almost any cut gasket. Makes reliable "formed-in-place" gaskets that resist cracking, shrinking and migrating. Coats pre-cut gaskets to increase reliability. Temperature range: -65°F to 500°F (-54°C to 260°C) intermittent; resists auto and shop fluids. Will not foul oxygen sensors when fully cured.

**Typical Applications:** Valve covers, oil pans, timing covers, water pumps, thermostat housings, transmission pans.

Item	Container Size	Pack
37461	80 ml tube	12
40482	190 ml power can aerosol	6
37525	300 ml cartridge	10



## LOCTITE® RTV RED SILICONE GASKET MAKER SENSOR SAFE/HI TEMP

Formulated for oxygen sensor-equipped engines. Temperature range: -75°F to 600°F (-59°C to 316°C) intermittent; resists auto and shop fluids, aging and thermal cycling without shrinking, cracking or hardening. Will not foul oxygen sensors when fully cured.

**Typical Applications:** Valve covers, oil pans, timing covers, water pumps, thermostat housings, transmission pans.

Item	Container Size	Pack
37469	80 ml tube	12
40465	190 ml power can aerosol	6
37529	7.25 oz. pressurized can	12
37528	300 ml cartridge	10



## LOCTITE® READY GASKET GASKET MAKER

Makes high performance leakproof gaskets in one minute. This elastomeric rubber gasket technology is blowout resistant, sensor safe and outperforms pre-cut gaskets. Equipment can be returned to service immediately. Specified on production lines by GM, Ford and Chrysler. Temperature range: -75°F to 450°F (-60°C to 232°C) continuous, 500°F (260°C) intermittent; resists ATF, coolant, oil and other shop fluids. Protects against leaks caused by vibration and thermal expansion.

**Typical Applications:** Automotive and marine gaskets, valve covers, gearbox covers, pumps, compressors, oil pans, thermostat housings, water pumps.

Item	Container Size	Pack
37512	5 oz. cartridge	6
40480	190 ml power can aerosol	6
37510	7 oz. pressurized can	6





# GASKETING



## LOCTITE® GASKET MAKER 515™ ANAEROBIC

Flexible gasketing material for use on rigid machined flanges with less than 0.015" (0.381 mm) gap. OEM approved – use where OEs specify 515™ or “anaerobic” gasket (cures in absence of air). Eliminates preformed, pre-cut, paper, rubber and cork gaskets. Flexes with flanges that move in service. See properties chart on page 27.



**Typical Applications:** Water pumps, thermostat housings, transmission pans, transmission case covers, transaxle casings, O-ring replacement.

Item	Container Size	Pack
38655	50 ml tube	6



## LOCTITE® HI-TACK STICK GASKET DRESSING

Formulated to work like LOCTITE® Hi-Tack Gasket Sealant liquid, but this wax-like stick is less messy, has a low odor, and is solvent-free. LOCTITE® Hi-Tack Stick sets quickly to a very tacky film, and seals and holds the heaviest gaskets in place. Resists gasoline, oil, and common shop fluids. See properties chart on page 27.

**Typical Applications:** Valve covers, fuel pumps, carburetors, manifold gaskets.

Item	Container Size	Pack
39158	19 g stick	6



## LOCTITE® GASKET MAKER 518™ ANAEROBIC

Noncorrosive anaerobic designed primarily for use on aluminum, iron and steel flanged mating surfaces. Ideal for on-the-spot and emergency repairs, or when a conventional gasket is out of stock. Fills gaps up to 0.050" (1.27 mm) and forms a flexible, solvent-resistant seal that will not tear or decay. Parts disassemble easily, even after extended service, and old gasket material can be removed with a putty knife. See properties chart on page 27.



**Typical Applications:** Water pumps, thermostat housings, transmission pans, transmission case covers, transaxle casings, O-ring replacement.

Item	Container Size	Pack
37394	50 ml tube	6
37530	300 ml cartridge	10



# GASKETING



## LOCTITE® GASKET SEALANT 1 HARD SETTING

Reliable, paste-like gasket sealant/dressing/coating. Dries quickly to a hard set. Recommended for rigid, permanent assemblies. Temperature range: -65°F to 400°F (-54°C to 204°C); resists common shop fluids and fuels.



**Typical Applications:** Antifreeze plugs, threaded connections, manifold gaskets.

Item	Container Size	Pack
37542	3 oz. tube	12



## LOCTITE® HI-TACK GASKET SEALANT GASKET DRESSING

Fast-drying sealant dries to a highly tacky, non-brittle film that holds gaskets in place during assembly. Temperature range: -65°F to 500°F (-54°C to 260°C); resists gasoline, oil, antifreeze, axle lube.

**Typical Applications:** Valve covers, fuel pumps, carburetors, manifold gaskets.

Item	Container Size	Pack
37555	9 oz. aerosol can	12
1537776	16 oz. brushtop can	12



## LOCTITE® GASKET SEALANT 2 NON-HARDENING

Reliable, paste-like gasket sealant/dressing/coating. Sets more slowly to a pliable film. Best suited for non-rigid, vibrating assemblies. Allows for easy disassembly if required. Temperature range: -65°F to 400°F (-54°C to 204°C); resists common shop fluids and fuels.



**Typical Applications:** Valve cover gaskets, oil pan gaskets.

Item	Container Size	Pack
37544	3 oz. tube	12



## LOCTITE® COPPER GASKET ADHESIVE HI-TEMP ADHESIVE SEALANT

Fast-drying, metallic copper sealant helps dissipate heat, prevents gasket burnout and improves heat transfer. Seals instantly. Fills hot spots and surface imperfections. Temperature range: -50°F to 500°F (-46°C to 260°C); resists all types of automotive fluids, especially gasoline.

**Typical Applications:** Cylinder head gaskets, carburetor gaskets, exhaust manifold gaskets and other high temperature applications.

Item	Container Size	Pack
37583	9 oz. aerosol can	12



## LOCTITE® AVIATION GASKET SEALANT GASKET DRESSING

Slow-drying, non-hardening brushtop sealant approved for use in aviation as well as automotive applications. Temperature range: -65°F to 400°F (-54°C to 204°C); resists gasoline, oil and grease.



**Typical Applications:** Close-fitting machined surfaces, sealing hoses, solid gaskets.

Item	Container Size	Pack
1525607	16 oz. brushtop can	12



# GASKETING

## Gasketing Selector Charts

GENERAL COMPARISON	GASKET TYPE		
	Conventional Gasket Dressings	Formed-in-Place Anaerobics	Formed-in-Place Silicones
<b>BENEFITS</b>	Versatile, immediate green strength (sticky)	Improved structural strength, long open time, high pressure seal	High gap filling, resistant to dynamic fatigue, on-line pressure testing
<b>LIMITATIONS</b>	Non-curing, limited gap fill, % shrinkage	Limited fill	Short open time
PROCESS CONSIDERATIONS	GASKET TYPE		
	Conventional Gasket Dressings	Formed-In-Place Anaerobics	Formed-In-Place Silicones
<b>NUMBER OF COMPONENTS</b>	1	1	1
<b>CURE METHOD</b>	Not Applicable	Anaerobic	RTV
<b>CURE TEMPERATURE</b>	Room Temperature	Room Temperature	Room Temperature
<b>CURE SPEED</b>			
<b>INITIAL CURE</b>	Immediate	15 to 30 minutes	15 to 30 minutes
<b>FULL CURE</b>	Not Applicable	24 to 72 hours	1 to 7 days
<b>PROCESSING OPTIONS</b>			
<b>MANUAL</b>	Yes	Yes	Yes
<b>AUTOMATED</b>	No	Yes	Yes

PERFORMANCE CONSIDERATIONS	GASKET TYPE		
	Conventional Gasket Dressings	Formed-in-Place Anaerobics	Formed-in-Place Silicones
<b>TEMPERATURE RESISTANCE</b>			
<b>CONTINUOUS OPERATION</b>	-65°F to 400°F (-54°C to 204°C)	-40°F to 300°F (-40°C to 149°C)	-60°F to 400°F (-51°C to 204°C)
<b>MAXIMUM</b>	600°F (316°C)	400°F (204°C)	725°F (385°C)
<b>FLUID RESISTANCE</b>			
<b>OIL</b>	Yes	Yes	Yes
<b>WATER/GLYCOL</b>	Yes	Yes	Yes
<b>FUEL</b>	Limited	Limited	No
<b>TRANSMISSION FLUID</b>	Yes	Yes	Yes
<b>GAP FILL</b>			
<b>IDEAL</b>	0.001" to 0.005"	0.001" to 0.005"	0.001" to 0.125"
<b>MAXIMUM</b>	0.010" (0.254 mm)	0.050" (1.27 mm)	0.240" (6.096 mm)
<b>INSTANT SEAL</b>	High Pressure	Low Pressure	Low Pressure
<b>FLANGE TYPE</b>	Rigid or Flexible	Rigid	Rigid or Flexible
<b>SUITABLE FOR USE WITH:</b>			
<b>METALS</b>	Yes	Yes	Yes
<b>PLASTICS*</b>	Yes	No	Yes

## Properties Chart: Gasketing

LOCTITE® PRODUCT	Part Number	Container	Color	Viscosity (cP)	Temperature Range	Sealing Time	Agency Approvals
<b>515™</b>	38655	50 ml tube	Purple	275,000/950,000 Thixotropic paste	-65° to 300°F (-54°C to 149°C)	15 min-2 hrs. w/primer 1-12 hrs. w/o primer	UL Classified for U.S.
<b>518™</b>	37394 37530	50 ml tube 300 ml cartridge	Red	800,000/3,750,000 Thixotropic paste	-65° to 300°F (-54°C to 149°C)	30 min-4 hrs. w/primer 4-24 hrs. w/o primer	CFIA
<b>Hi-Tack Stick</b>	39158	19 g stick	Purple	Vertical applications, repositionable	-65° to 300°F (-54°C to 149°C)	5 minutes to set	•

\* Uncured liquid adhesives may cause stress cracking of certain thermoplastics (e.g., polycarbonates, acrylic and polysulfone).



# GASKETING

## Properties Chart: Gasketing

LOCTITE® PRODUCT	Part Number	Container	Color	Oil Resistance	Noncorrosive	Temperature Range	Sealing Time	Agency Approvals
<b>Ready Gasket</b>	37512 40480 37510	5 oz. cartridge 190 ml power can aerosol 7 oz. can	Black	Increased oil resistance	Noncorrosive	-75° to 500°F (-59° to 260°C) intermittent	Operating Strength 15 psi - 1 min.	GM 998-5990 Ford WSE-M4G 323-A6 Chrysler GF-44-A
<b>RTV Blue Silicone</b>	37461 40482 37525	80 ml tube 190 ml power can aerosol 300 ml cartridge	Blue	•	•	-65° to 500°F (-54° to 260°C) intermittent	Tack-free 30 min. — Full Strength 24 hrs.	•
<b>RTV Red Silicone</b>	37469 37529 40465 37528	80 ml tube 7.25 oz. can 190 ml power can aerosol 300 ml cartridge	Red	•	•	-75° to 600°F (-59° to 316°C) intermittent	Tack-free 30 min. — Full Strength 24 hrs.	CFIA
<b>RTV 598™ Black Silicone</b>	37472 37467 40463 37519 37518	0.37 oz. tube 80 ml tube 190 ml power can aerosol 8.75 oz. can 300 ml cartridge	Black	Excellent oil resistance	Noncorrosive	-75° to 625°F (-59° to 329°C) intermittent	Tack-free 30 min. — Full Strength 24 hrs.	American Bureau of Shipping, CFIA
<b>RTV 587™ Blue Silicone</b>	37465 40462 37516	80 ml tube 190 ml power can aerosol 300 ml cartridge	Blue	Increased oil resistance	Noncorrosive	-75° to 500°F (-59° to 260°C) intermittent	Tack-free 30 min. — Full Strength 24 hrs.	American Bureau of Shipping, UL Classified for U.S., CFIA
<b>RTV 5920™ Copper Silicone</b>	37466 37517	80 ml tube 300 ml cartridge	Copper	Increased oil resistance	Noncorrosive	-65° to 700°F (-54° to 371°C) intermittent	Tack-free 60 min. — Full Strength 24 hrs	CFIA
<b>RTV 5699™ Grey Silicone</b>	37464 40505	80 ml tube 190 ml power can aerosol	Grey	Increased oil resistance	Noncorrosive	-75° to 625°F (-59° to 329°C) intermittent	Tack-free 30 min. — Full Strength 24 hrs.	CFIA
<b>Aviation Gasket Sealant</b>	1525607	16 oz. brushtop can	Dark reddish brown	Oil resistant	Noncorrosive	-65° to 400°F (-54° to 204°C)	Full Strength 12 hrs.	•
<b>Gasket Sealant 1</b>	37542	3 oz. tube	Reddish brown	Oil resistant	Noncorrosive	-65° to 400°F (-54° to 204°C)	Full Strength 24 hrs.	•
<b>Gasket Sealant 2</b>	37544	3 oz. tube	Black	Oil resistant	Noncorrosive	-65° to 400°F (-54° to 204°C)	Remains tacky	•
<b>Hi-Tack Gasket Sealant</b>	37555 1537776	9 oz. aerosol 16 oz. brushtop can	Red	Increased oil resistance	Noncorrosive	-65° to 500°F (-54° to 260°C) Aerosol to 600°F	5 min. to set	•
<b>Copper Gasket Adhesive</b>	37583	9 oz. aerosol	Copper	Oil resistant	Noncorrosive	-50° to 500°F (-45° to 260°C)	Remains tacky	•

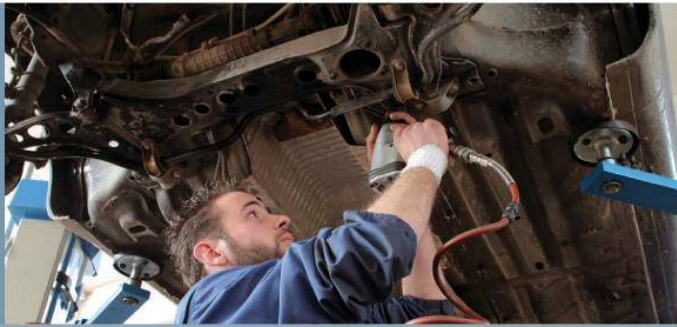

# LUBRICANTS

## Reduce wear and tear.

LOCTITE® anti-seize and lubricating compounds are a group of premium quality products developed to protect metal parts from corrosion, galling and seizing. They ease assembly and disassembly of slip-fit, press-fit and threaded joints, and reduce friction and wear at temperatures up to 1800°F. Formulated for severe environments, these products protect against high temperatures, heavy loads, chemicals, pounding and vibration.



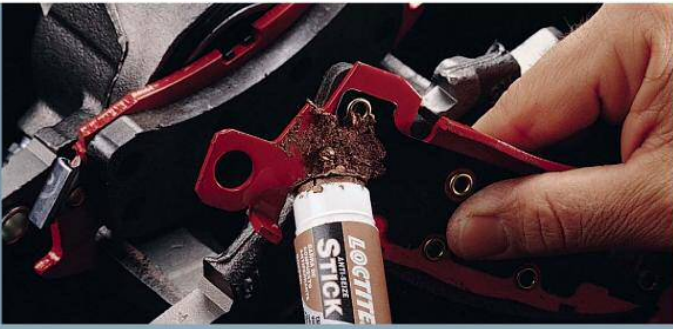

## LUBRICANTS



### LOCTITE® COPPER ANTI-SEIZE STICK

LOCTITE® Copper Anti-Seize Stick provides a shield against high temperature seizing and galling. Studs, bolts, flanges and other mated parts can be removed easily in typical dry service temperatures up to 1800°F (982°C). The copper anti-seize stick can be used on copper, brass, cast iron, all steel alloys including stainless steel, all plastics and all non-metallic gasketing materials.

**Typical Applications:** Spark plug threads installed in aluminum, exhaust manifold bolts, engine bolts, thermostat housing bolts, oxygen sensors, battery cable connections.

Item	Container Size	Pack
37616	20 g stick	6



### LOCTITE® SILVER ANTI-SEIZE STICK

LOCTITE® Silver Anti-Seize Stick is a heavy-duty, temperature-resistant, petroleum-based lubricant compound fortified with graphite and metallic flake. Will not evaporate or harden in extreme cold or heat. Use during assembly to prevent seizing, galling, and corrosion. For use in assemblies up to 1600°F (871°C).

**Typical Applications:** For easy removal of spark plugs, cylinder head and exhaust head bolts.

Item	Container Size	Pack
37617	20 g stick	6



### LOCTITE® ANTI-SEIZE LUBRICANT COPPER

A premium quality copper anti-seize and thread lubricant that may be used to prevent seizing, corrosion, and galling where high temperature conditions exist. Temperature range: -30°F to 1800°F (-34°F to 982°C). Provides good electrical conductivity.

**Typical Applications:** Spark plug threads installed in aluminum, exhaust manifold bolts, engine bolts, oxygen sensors, knock sensors, thermostat housing bolts, fuel filter fittings, and battery cable connections.

Item	Container Size	Pack
38650	8 oz. brushtop can	12
37562	1 lb. brushtop can	12



### LOCTITE® ANTI-SEIZE LUBRICANT SILVER

Heavy-duty, temperature-resistant, petroleum-based lubricant compound fortified with graphite and metallic flake. Will not evaporate or harden in extreme cold or heat. Use during assembly to prevent seizing, galling and corrosion. For use in assemblies up to 1600°F (871°C).

**Typical Applications:** For easy removal of spark plugs, cylinder head and exhaust head bolts.

Item	Container Size	Pack
37539	1 oz. tube	12
37565	8 oz. brushtop can	12
38658	12 oz. aerosol can	12
37566	1 lb. brushtop can	12



# LUBRICANTS



## LOCTITE® DISC BRAKE QUIET STICK ELIMINATES NOISE

Invented and patented by Henkel, this unique wax-like stick is specially formulated to dampen brake pad vibrations and eliminate associated squeaking and noise, without the sticky, smelly mess of traditional solvent and water-based products. LOCTITE® Disc Brake Quiet Stick forms a water-resistant, high temperature film that will absorb vibration and quiet disc braking.

**Typical Applications:** Apply to disc brake pads at point of contact with caliper.

Item	Container Size	Pack
40300	19 g stick	6

### LOCTITE® DISC BRAKE QUIET STICK IS

The only brake squeal product tested that fully meets OEM acceptance criteria.

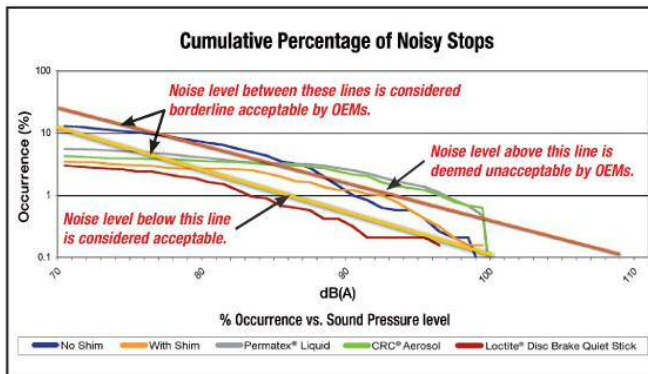

The table below shows the products tested listed in the order of the number of noise events. By studying this table and the adjacent graph, it can be determined that, during these tests, LOCTITE® Disc Brake Quiet Stick was the most effective at reducing brake noise events.

Tested Products	Number of Noise Events	Noise Level
LOCTITE® Disc Brake Quiet Stick	64	Quietest
CRC® Disc Brake Quiet Aerosol	76	I
Permatex® Disk Brake Quiet Liquid	100	I
Baseline with Shim	245	I
Baseline without Shim	245	Noisiest

Test results are based on independent brake noise testing done by Link Testing Laboratories, Inc. using Henkel products and Henkel's competitors' commercially available products. Link Testing Laboratories, Inc. does not endorse or recommend any product. Link Testing Laboratories, Inc. guarantees accuracy and consistency of test results, which are valid for these products under the conditions tested. Any use or reproduction of Link Testing Laboratories, Inc. name, logo, or the name of a Link Testing Laboratories engineer must be approved by Link Testing Laboratories, Inc. before publication. Henkel Corporation has obtained permission from Link Testing Laboratories, Inc. to reproduce the above graph and table.



# LUBRICANTS



## LOCTITE® DIELECTRIC TUNE-UP GREASE LUBRICANT

Provides a moisture-proof barrier that lubricates and protects electrical connections and wiring from salt, dirt and corrosion. Extends the life of bulb sockets. Prevents voltage leakage around electrical connections. Required for modern high energy ignition systems.

**Typical Applications:** Marine and automotive electrical connections, spark plug boots, trailer hitches, battery terminals.



Item	Container Size	Pack
37534	0.33 oz. tube	12
37535	80 ml tube	6



## LOCTITE® FREEZE & RELEASE

LOCTITE® Freeze & Release instantly freezes seized and rusted parts (bolts, nuts, studs) down to -38°F (-39°C). The exceptional shock-freeze effect causes microscopic cracks in the layer of rust, allowing the lubricant ingredient to wick directly into the rust by capillary action. The assembly can be easily dismantled after allowing only 1-2 minutes penetration time. Released parts remain lubricated and protected from corrosion.

**Typical Applications:** Seized and corroded assemblies of threaded and cylindrical parts. Any applications where a threadlocker or anti-seize has not been previously used, and rust and corrosion has formed.

Item	Container Size	Pack
996456	13.52 fl. oz. aerosol	6



## LOCTITE® LB 8027™ ENGINE ASSEMBLY LUBE

High performance liquid assembly lubricant cushions bearings, valve train parts and geared components for maximum metal-on-metal protection at start-up.

**Engine Applications:** Pre-lube valve train parts, wrist pins, rod bearing, main bearings, camshaft bearings, seals, etc.

**Manual and Automatic Transmission**

**Applications:** Gears, bushings, roller bearings and ball bearings.

Item	Container Size	Pack
1787494	4 oz.	12



## LOCTITE® LB 8028™ CAMSHAFT LUBE

Extreme pressure camshaft lubricant with molybdenum disulfide protects camshaft lobes from galling at start-up. Also ideal for flat tappet lifter faces and distributor gears.

**Typical Applications:** Camshaft lubrication used at time of gas & diesel engine assembly.

Item	Container Size	Pack
1787977	1 oz.	24



# LUBRICANTS

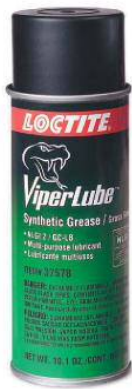

## LOCTITE® VIPERLUBE® SYNTHETIC GREASE

A high performance, NLGI grade 2/Severe duty GC-LB synthetic grease that provides superior protection for parts exposed to a wide range of temperatures and environments. NSF H1 rated.

**Typical Applications:** Use as a lubricant on all bearings, as a protective anti-rust film, or as a release agent on gaskets and seals. Use as a battery terminal protector.

Item	Container Size	Pack
36781	3 oz. tube	12
37578	10.1 oz. aerosol can	6
36782	400 g cartridge	12



## LOCTITE® BELT DRESSING & CONDITIONER

Extends belt life. Penetrates the cord fibers of "V" belts to restore pliability and flexibility. Prevents belt slippage due to heat, cold, dampness, dust and glazing. Eliminates squeaking and slipping.

**Typical Applications:** Fan belts, water pumps, power steering, sewing machines, washing machines, air conditioners, lawn mowers and power tools.

Item	Container Size	Pack
37581	5 oz. aerosol can	12



## LUBRICANTS



### LOCTITE® SILICONE LUBRICANT

Lubricates and waterproofs all types of mechanical equipment. Stops friction and squeaks. Coats hinges and channels. Prevents locks, doors and windows from binding. High silicone formula does not attract dust or dirt. Prevents binding, sticking and deterioration.

**Typical Applications:** Lubricates door locks, trunk lids, brake cables and rubber molding.

Item	Container Size	Pack
37584	13 oz. aerosol can	12



### LOCTITE® GEAR, CHAIN & CABLE LUBRICANT

Protects and prolongs the life of gears, chains, wire rope, and cable. Repels dirt, sand, and dust with minimum "throw-off" from centrifugal force. Cleans, lubricates, and protects all types of roller chains that operate under exposed conditions.

**Typical Applications:** Ideal for any chain-driven tool or vehicle such as motorcycles, mopeds, chainsaws, lawnmowers and bicycles.

Item	Container Size	Pack
37582	5 oz. aerosol can	12



### LOCTITE® PENETRATING OIL

Heavy-duty penetrant for rusted and frozen assemblies. Works quickly to penetrate and loosen rust, tar, grease, dirt, carbon deposits and corrosion from metal parts. Frees frozen nuts, bolts and fittings in all types of assemblies.

**Typical Applications:** Lubricates to free any corroded or seized part. Penetrates rust, scale, paint, varnish, carbon or gum.

Item	Container Size	Pack
37585	12 oz. aerosol can	12



If you want to repair, protect, seal, insulate or prevent corrosion, there's a LOCTITE® product for you. Whether you need to make a thread repair, or remove or prevent rust, Henkel has a LOCTITE® brand product that will make your parts and equipment last longer and work better.

## SPECIALTY PRODUCTS



### LOCTITE® CLOVER® LAPPING & GRINDING COMPOUND 280 GRIT

280 fine grit silicon carbide lapping compound ensures engine valves and valve seats are perfectly mated for maximum power and heat transfer.

**Typical Applications:** Lapping (abrasive compound) for use in ensuring proper fit of valves to valve seats in gas and diesel engines.

Item	Container Size	Pack
1777012	2 oz.	24



### LOCTITE® EXTEND® RUST NEUTRALIZER

Provides one-step rust treatment that destroys old rust, prevents new rust. Just brush or spray it on. Within minutes, rust disappears and is converted to a durable black protective coating. Surface rust must be present. Use as a primer or finish coat. Specially formulated to be used with body filler and fiberglass.

**Typical Applications:** Aerosol can is ideal for hard-to-reach automotive applications.

Item	Container Size	Pack
633877	10.25 oz. aerosol can	12
75430	1 quart bottle	10
1381192	8 oz. bottle	6



### LOCTITE® RUBBERIZED UNDERCOATING HEAVY-DUTY

This heavy-duty undercoating seals, protects and insulates. Rubberized for maximum durability. Excellent professional blend, all-purpose coating.

**Typical Applications:** Automotive frames, rocker panels, and wheels.

Item	Container Size	Pack
37580	16 oz. aerosol can	12



### LOCTITE® NAVAL JELLY® RUST DISSOLVER

The original rust treatment formula that has been used for over 25 years. It removes rust from metal surfaces such as iron and steel. Can be applied on metal surfaces by brushing or spraying.

**Typical Applications:** Iron railings, barbecue grills, automobiles, patio furniture, tools, antiques, mailboxes, lawn mowers, bicycles & lamp posts.

Item	Container Size	Pack
1381191	8 oz. bottle	6



## SPECIALTY PRODUCTS



### LOCTITE® FORM-A-THREAD® STRIPPED THREAD REPAIR KIT

Makes reliable thread repairs without drills, taps, tools or inserts. Restores worn, stripped or damaged threads and eliminates future corrosion, galling, seizing and rust. Allows up to 128 ft. lbs. of torque between -65°F and 300°F (-54°C and 149°C). Permanently repairs stripped threads and fasteners in five minutes (up to SAE Grade 5 English and 8.8 metric).

**Typical Applications:** Intake manifold bracket fastener threads, timing chain cover bolt threads, valve cover bolt threads, water pump bolt threads.

Item	Container Size	Pack
28654	4.8 ml kit	6



### LOCTITE® INSULATING & SEALING WRAP

LOCTITE® Insulating & Sealing Wrap is a non-sticky, self-fusing, multi-purpose wrap that stretches three times its size. Great for quick fixes anywhere, any time.

**Typical Applications:**

Jumper cable grip/insulating, emergency hose repair, exhaust wrap, tool handles.

Item	Container Size	Color	Pack
1212164	1" x 10' roll	Red	10
1496756	2" x 36' roll	Black	10
1540599	1" x 10' roll	Black	10

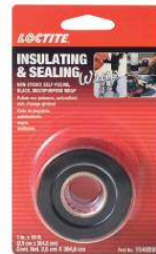

### LOCTITE® INDUSTRIAL HAND WIPES

Pre moistened 9.5" x 12" wipe. Abrasive enough to scrub off the toughest grease and grime without scratching hands or paint.

**Typical Applications:**

Removal of dried bugs from windshields, hoods and radiator grills. Cleans commercial working hands without water.

Item	Container Size	Pack
34943	75 count canister	6
34944	130 count bucket	4



# AUTOMOBILE ENGINE

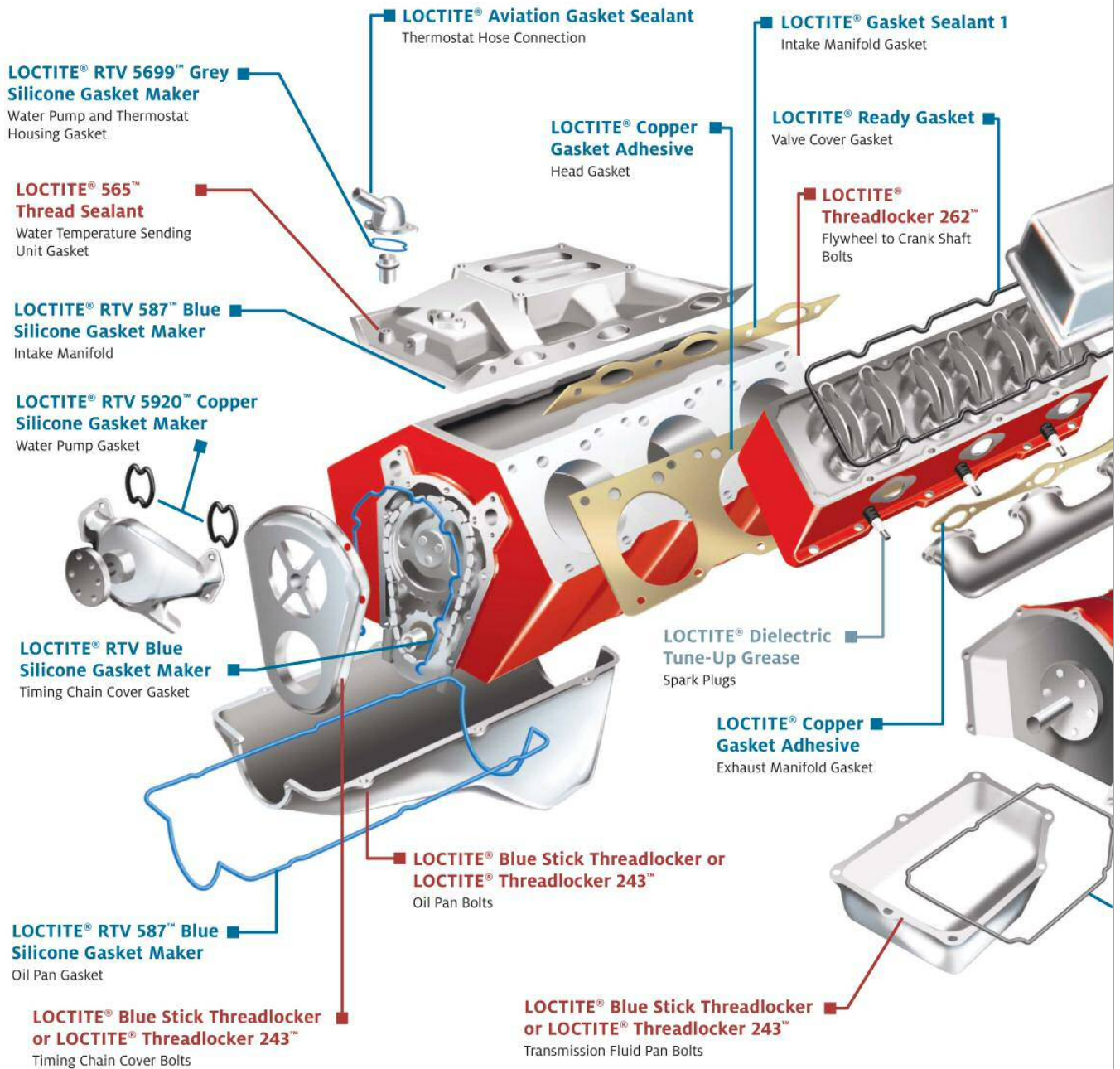

This diagram shows some of the many LOCTITE® product applications for automobile repairs. Most of these applications would also apply to heavy-duty vehicle or motorcycle repairs.

Log on to [www.henkelna.com/aam](http://www.henkelna.com/aam) and experience this application chart via our “Virtual Engine.”

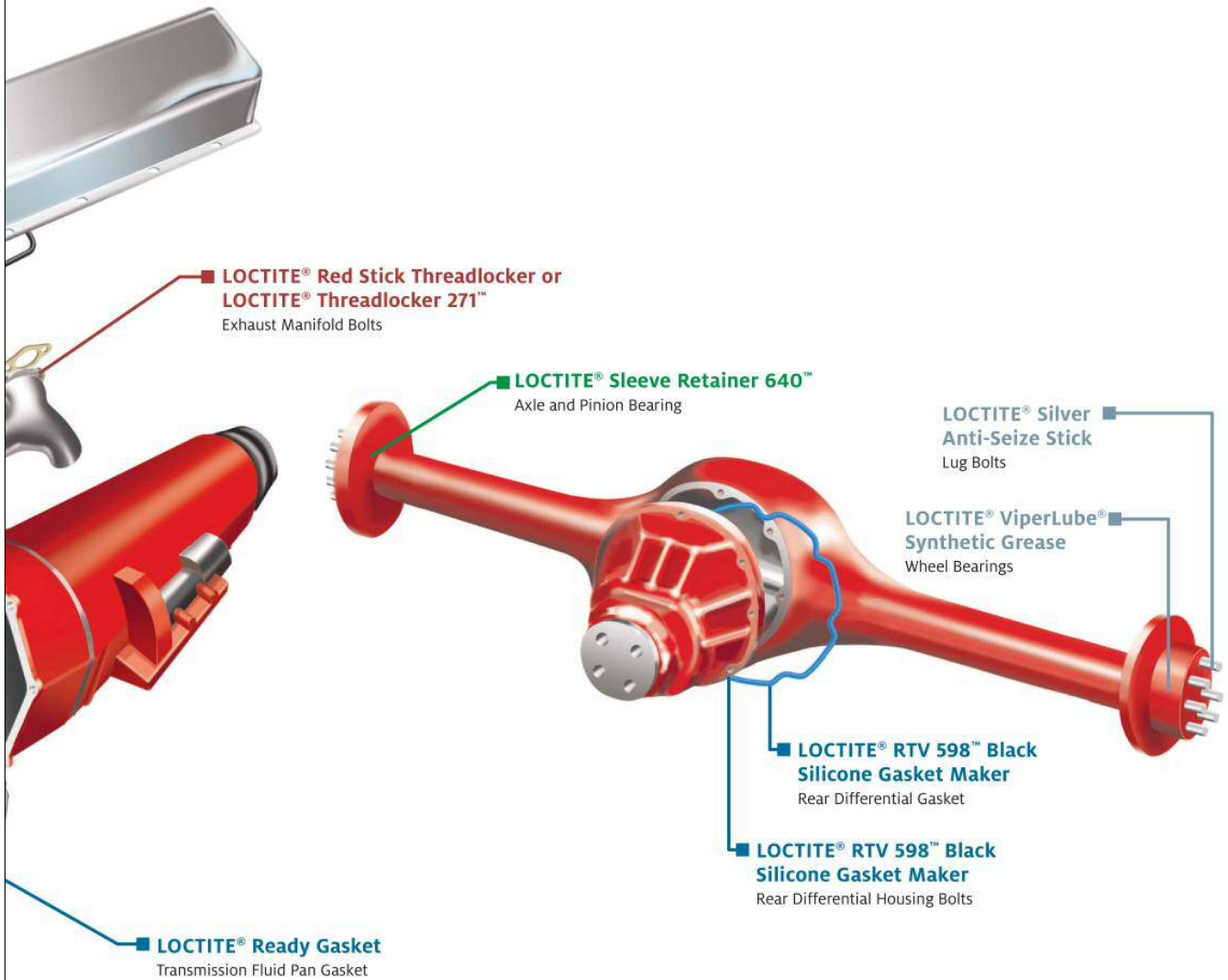

THREAD TREATMENTS

RETAINING COMPOUNDS

GASKETING

LUBRICANTS

# DIESEL ENGINE

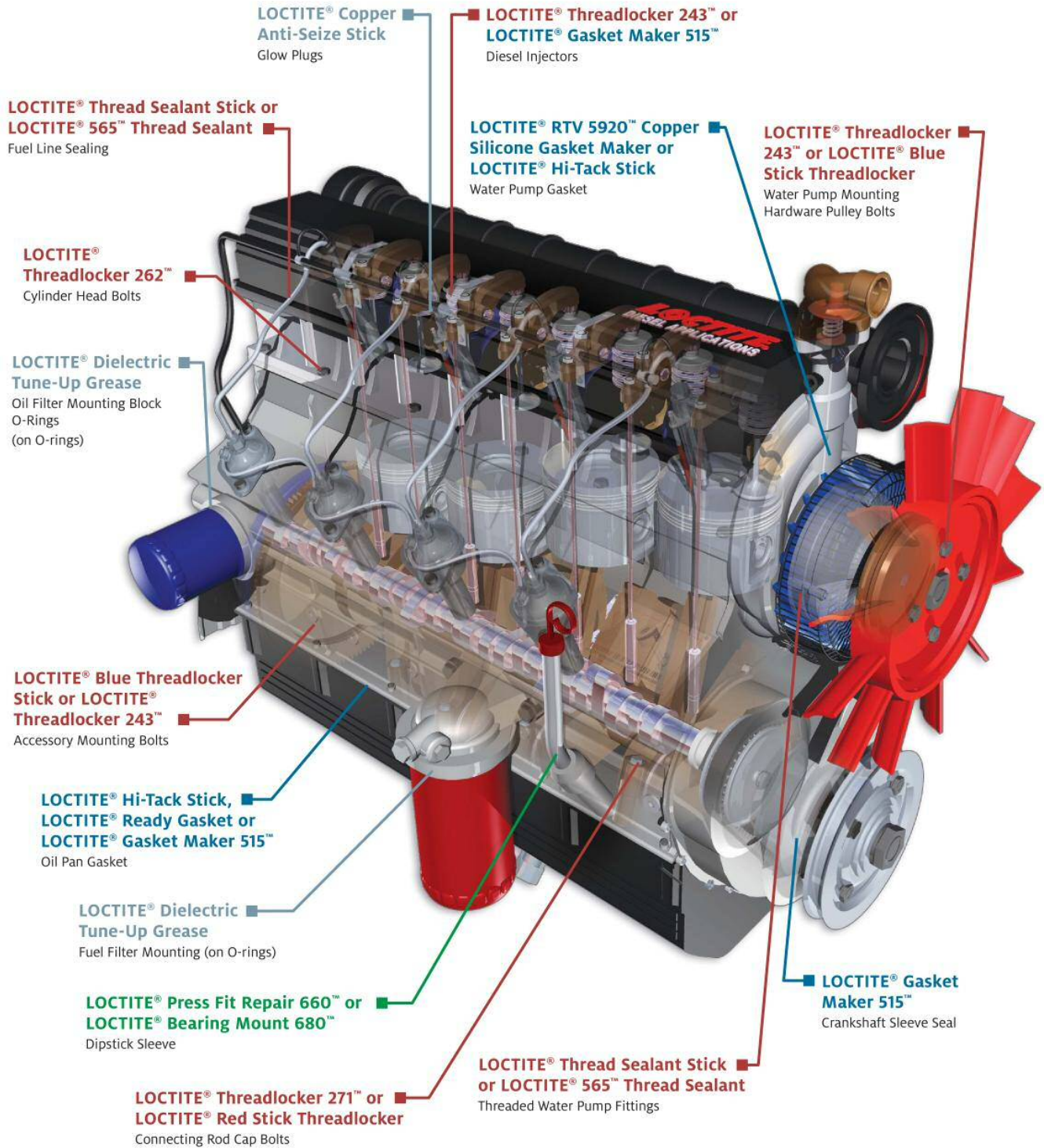

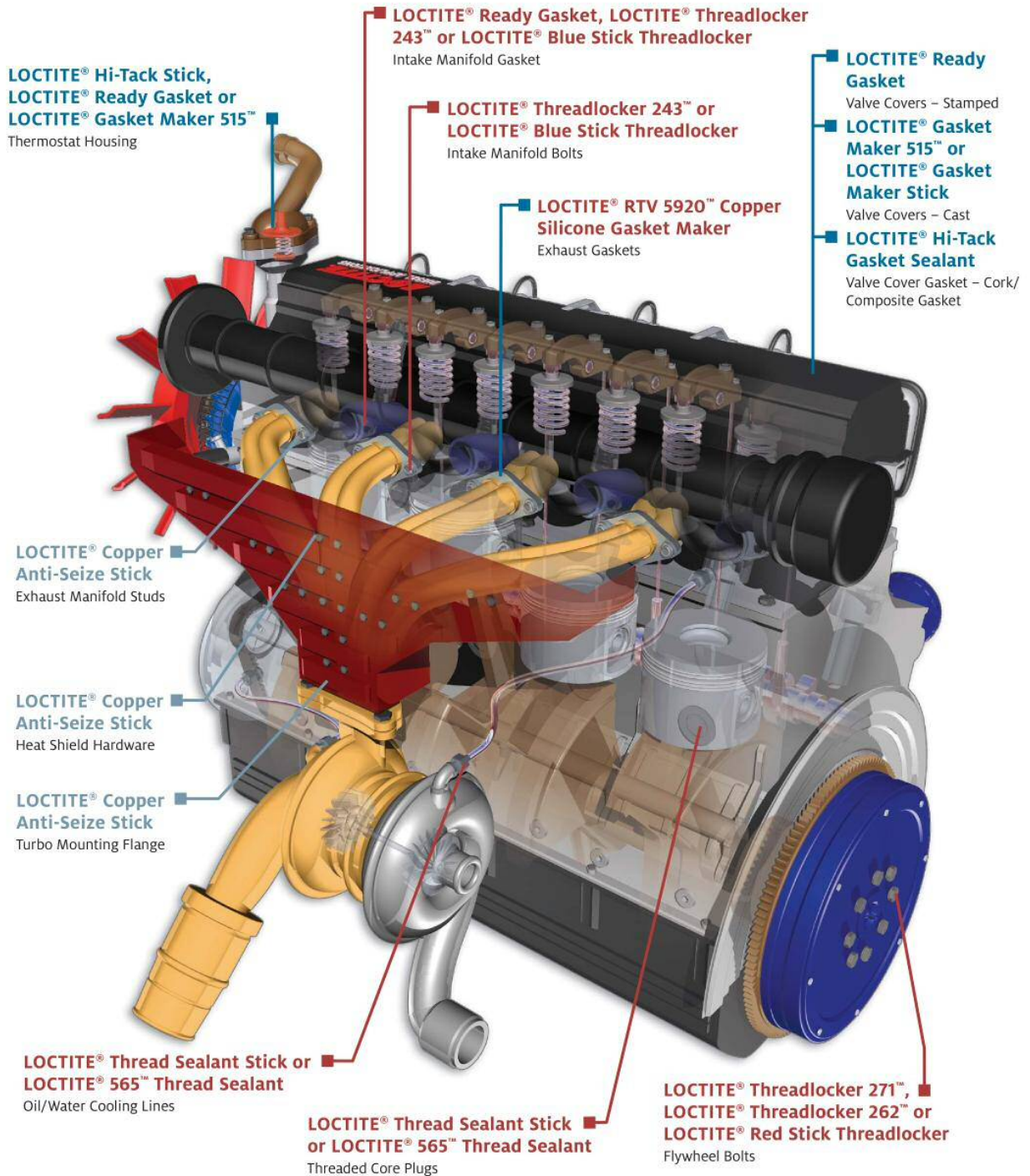

# HEAVY-DUTY DIFFERENTIAL/AXLE

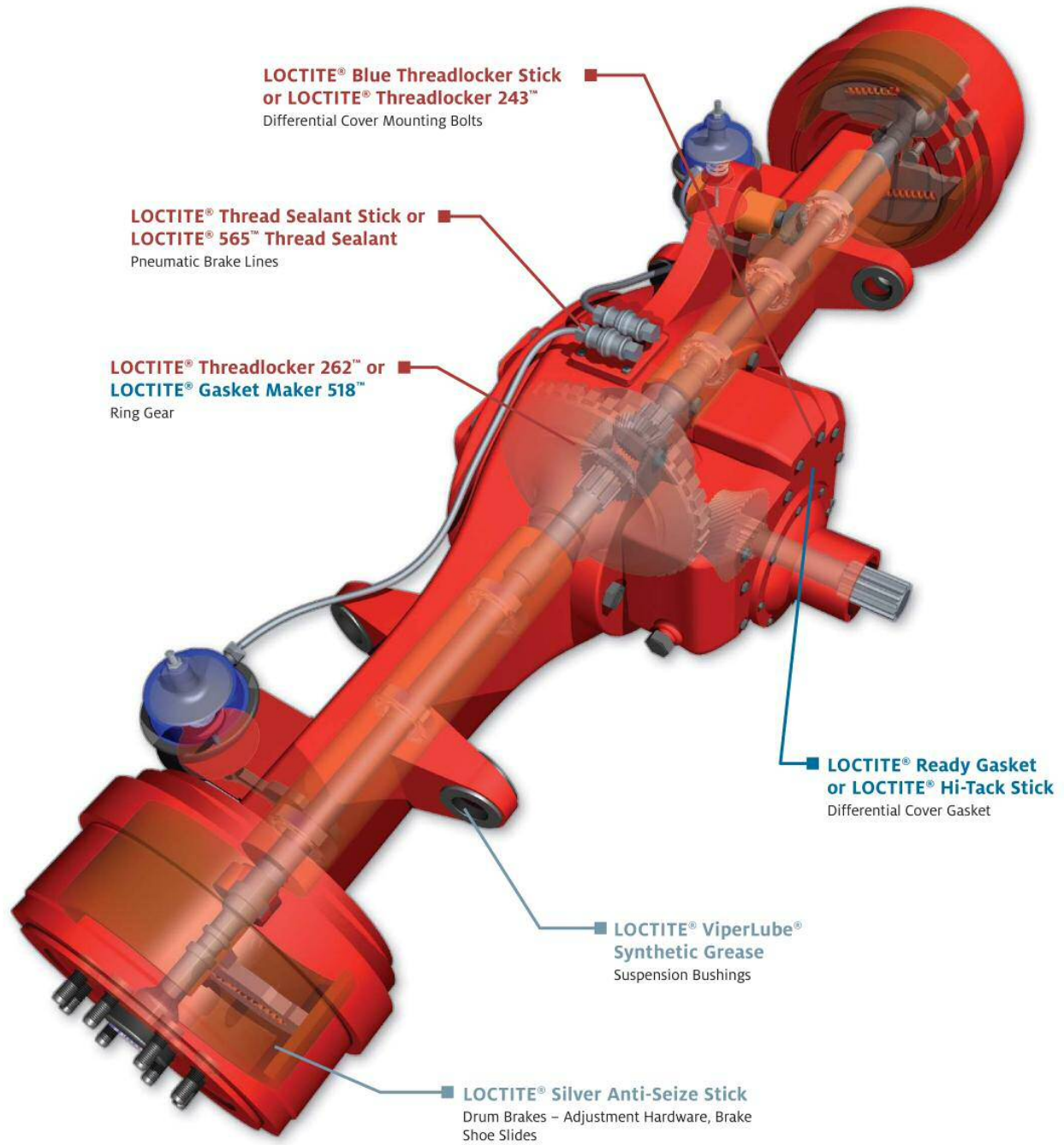

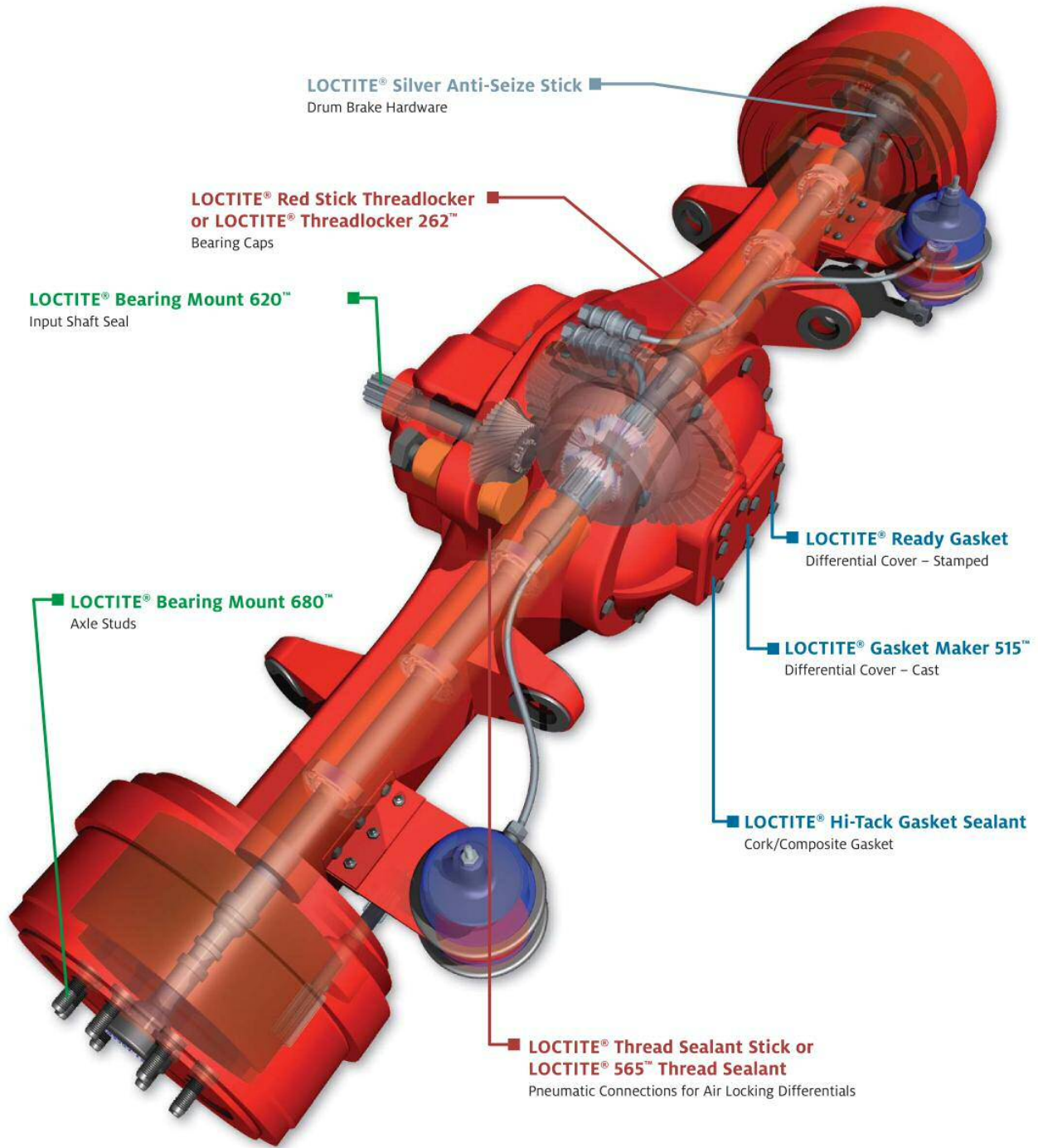

THREAD TREATMENTS

RETAINING COMPOUNDS

GASKETING

LUBRICANTS

# AUTOMOBILE TRANSMISSION

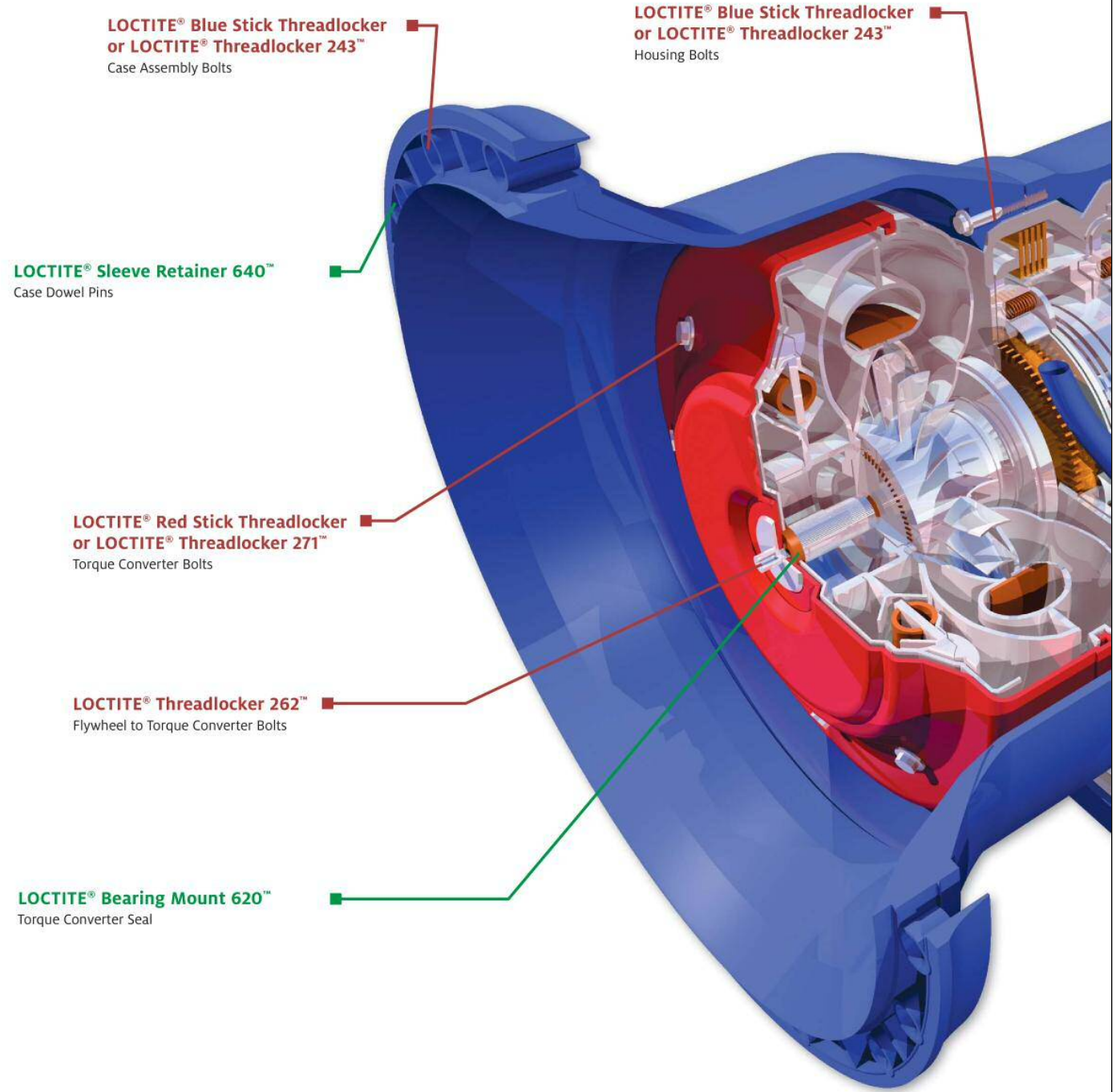

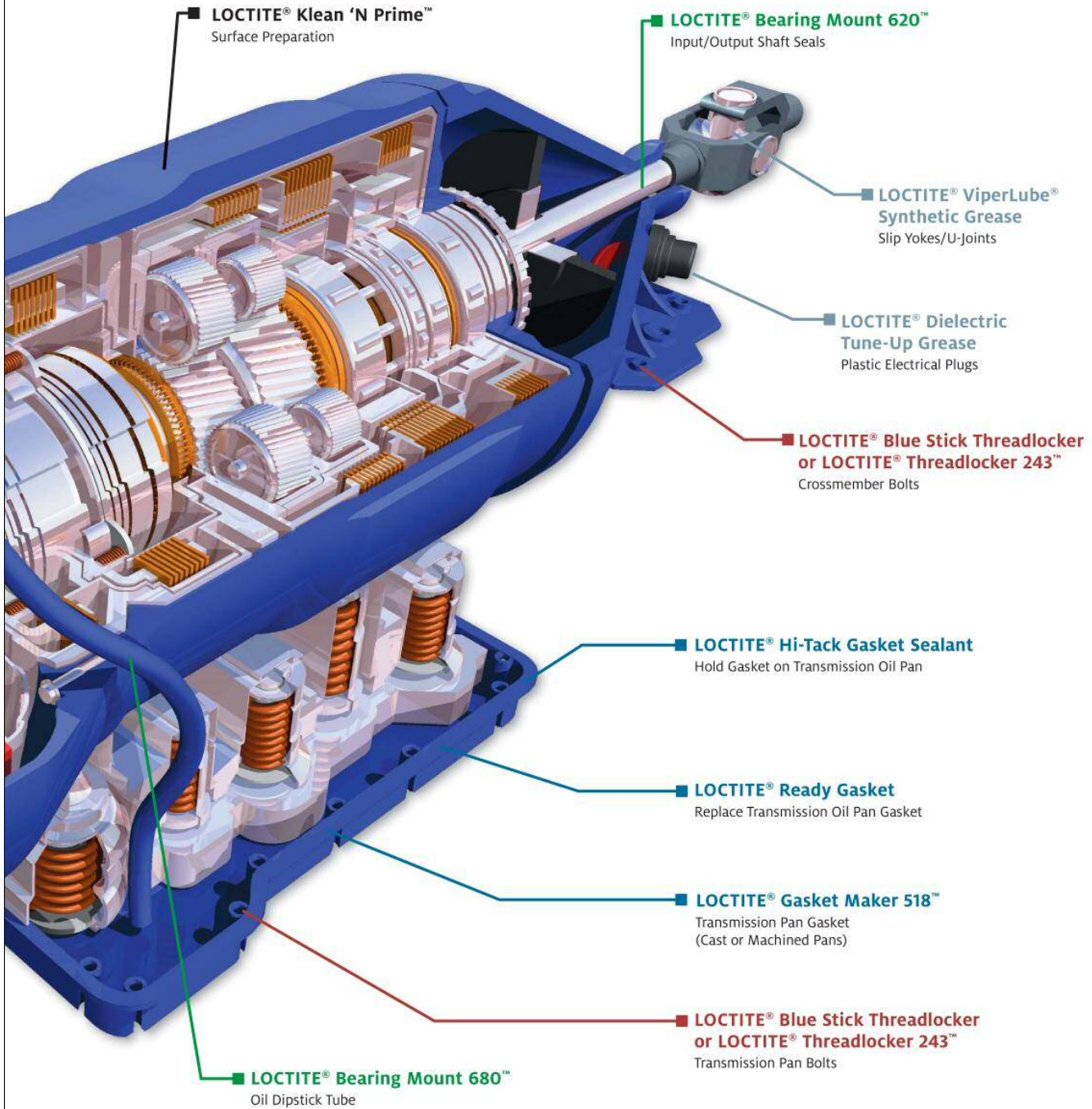

THREAD TREATMENTS

RETAINING COMPOUNDS

GASKETING

LUBRICANTS

# HEAVY-DUTY TRANSMISSION

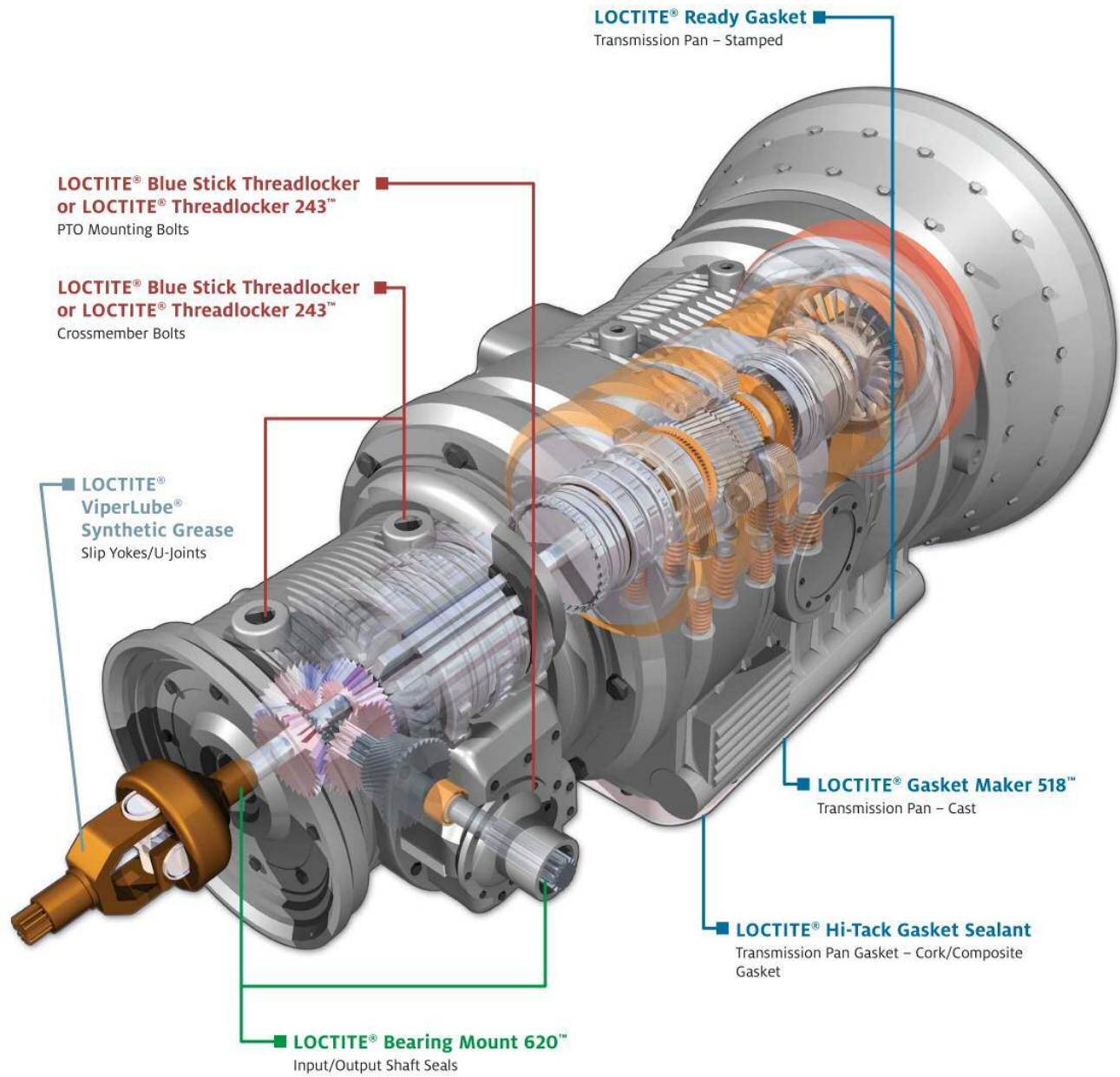

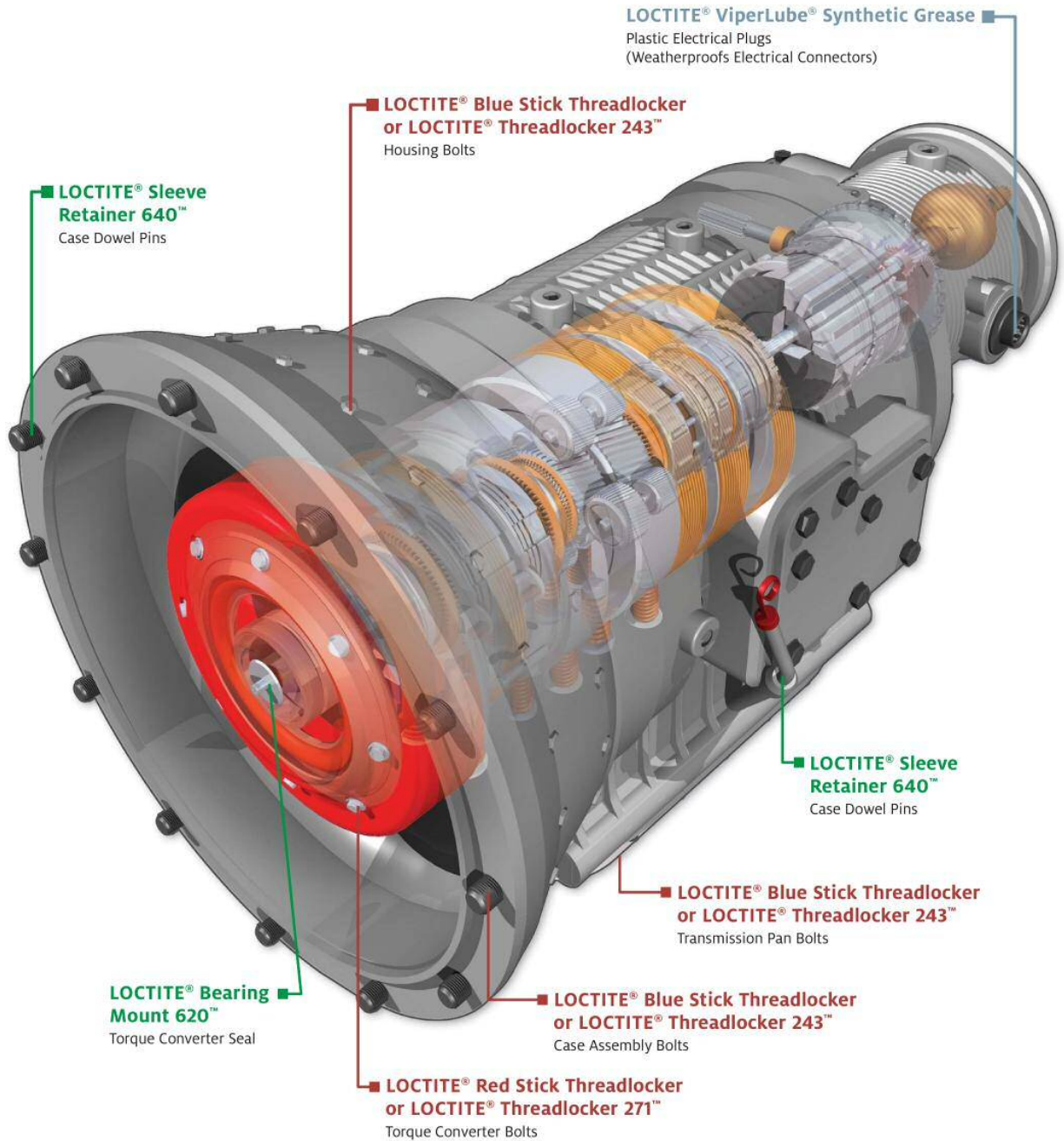

THREAD TREATMENTS

RETAINING COMPOUNDS

GASKETING

LUBRICANTS

# HEAVY-DUTY SUSPENSION

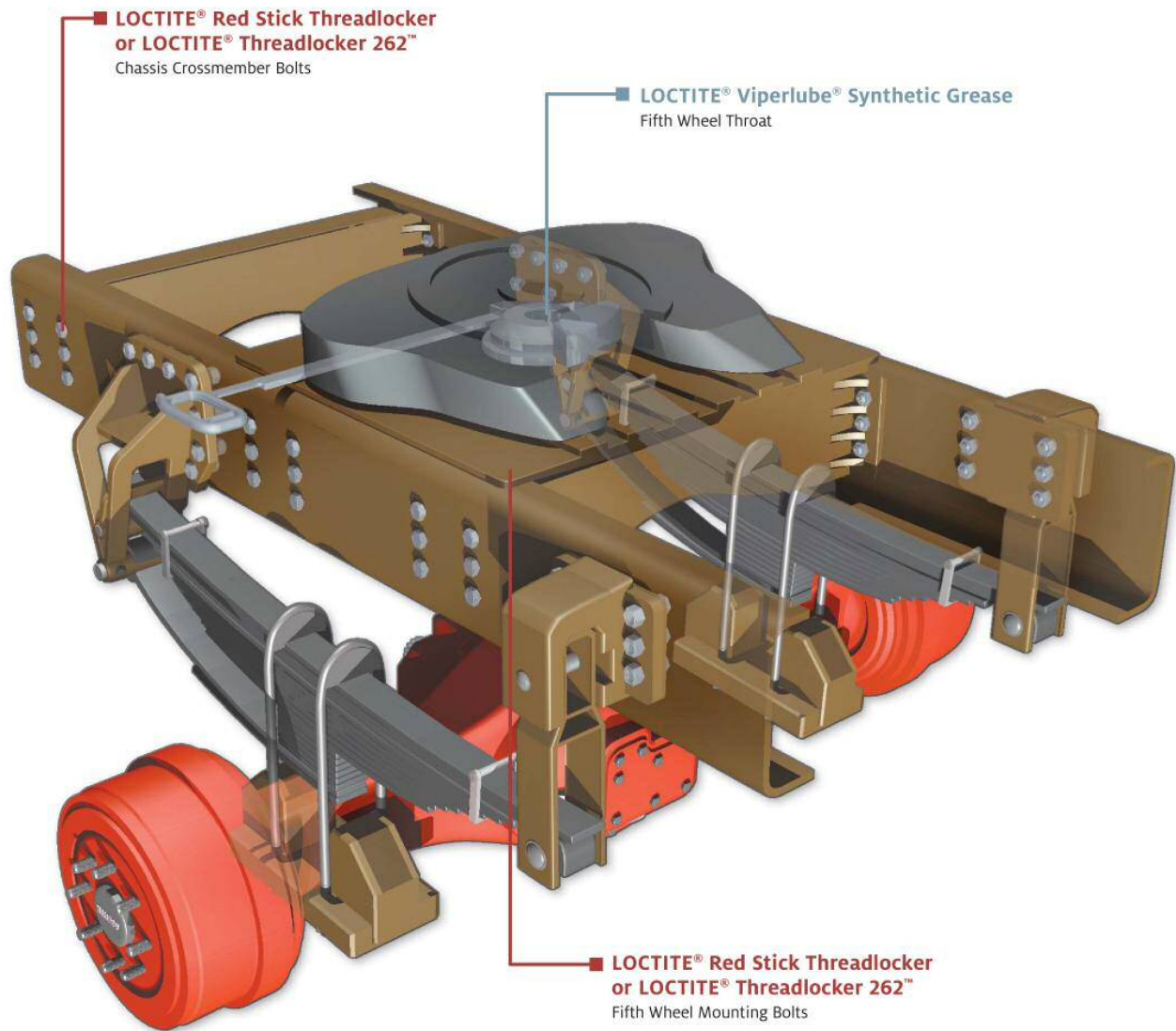

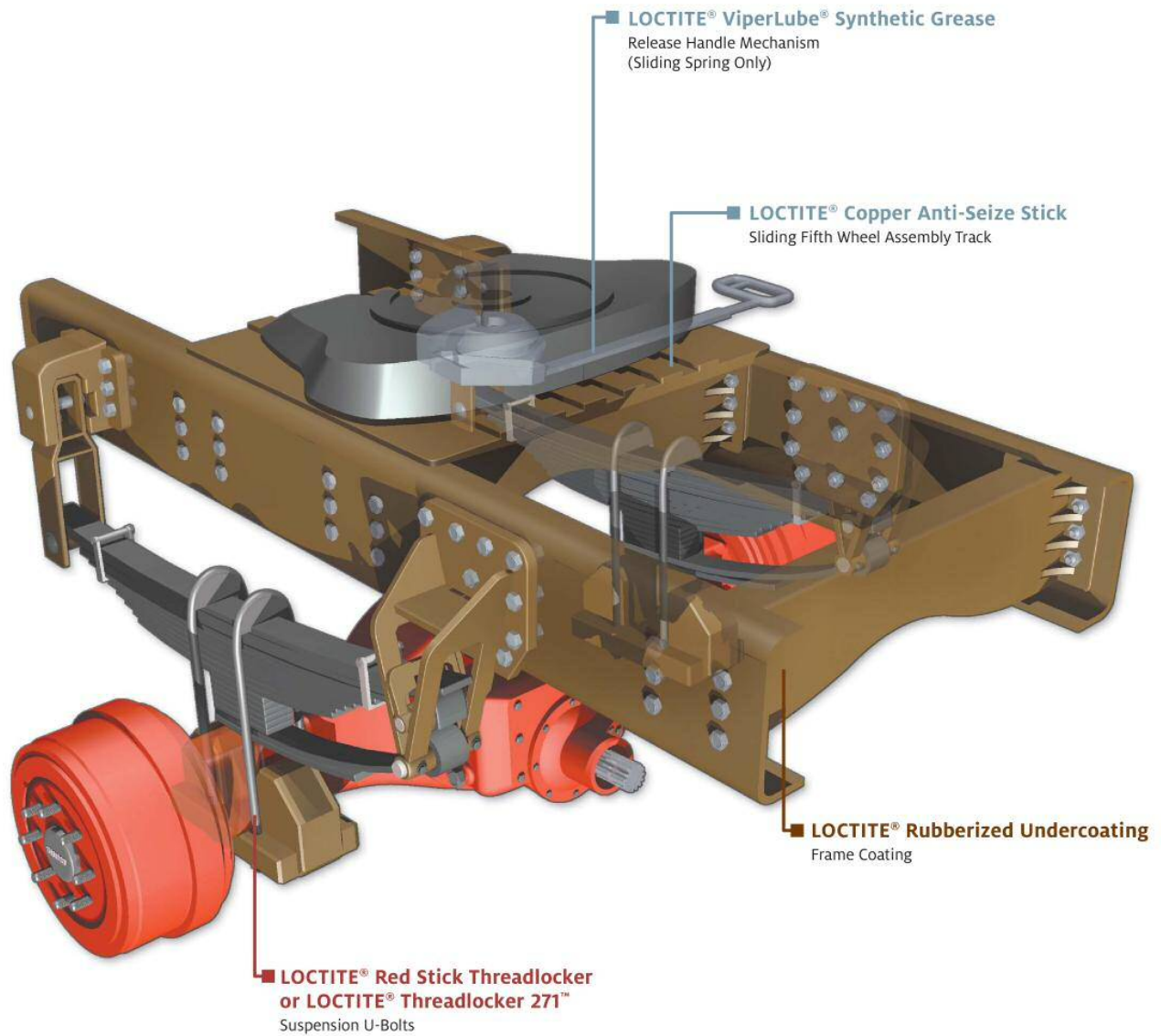

THREAD TREATMENTS

LUBRICANTS

SPECIALTY PRODUCTS

# MOTORCYCLE CHASSIS

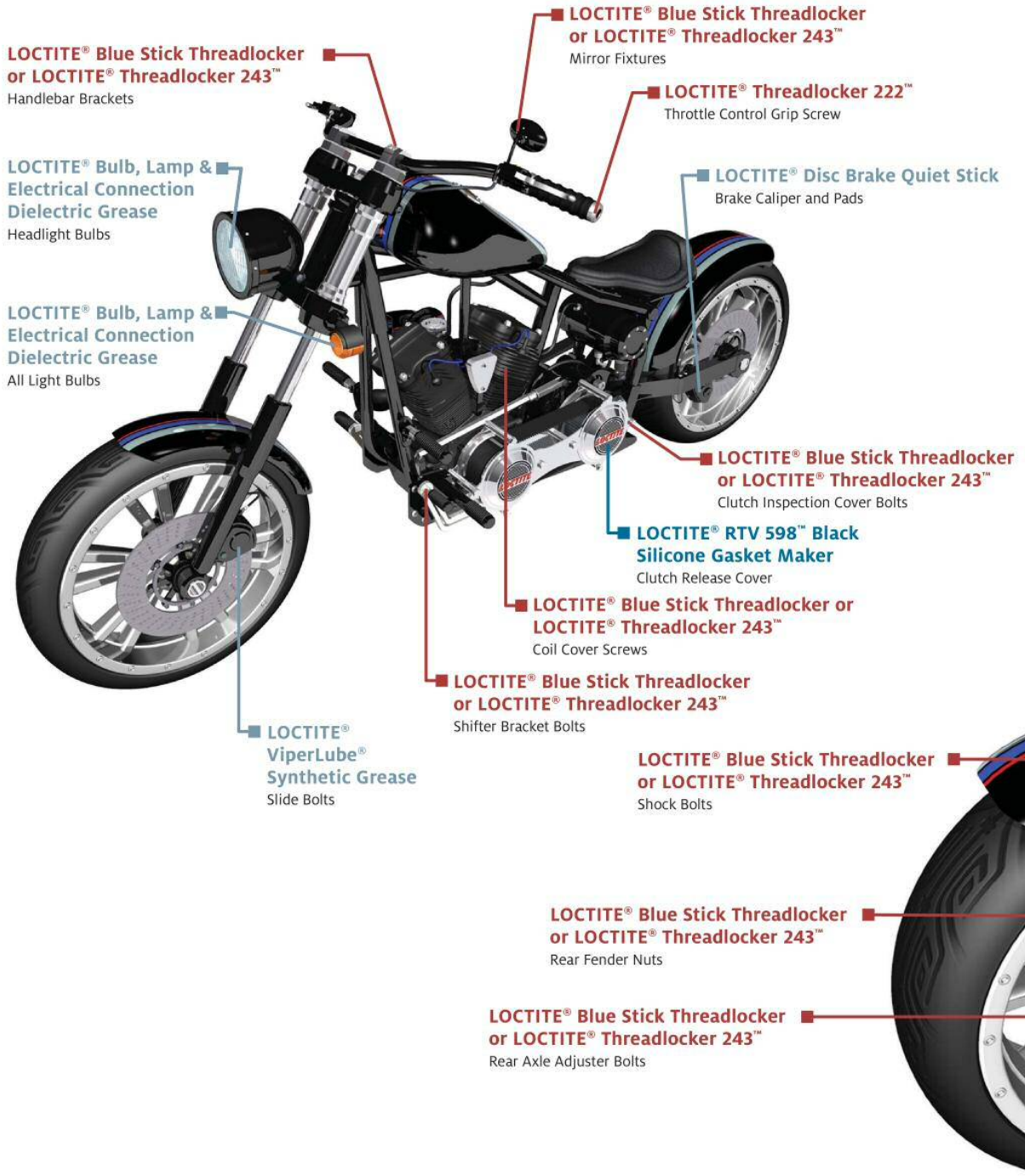

THREAD TREATMENTS

GASKETING

LUBRICANTS

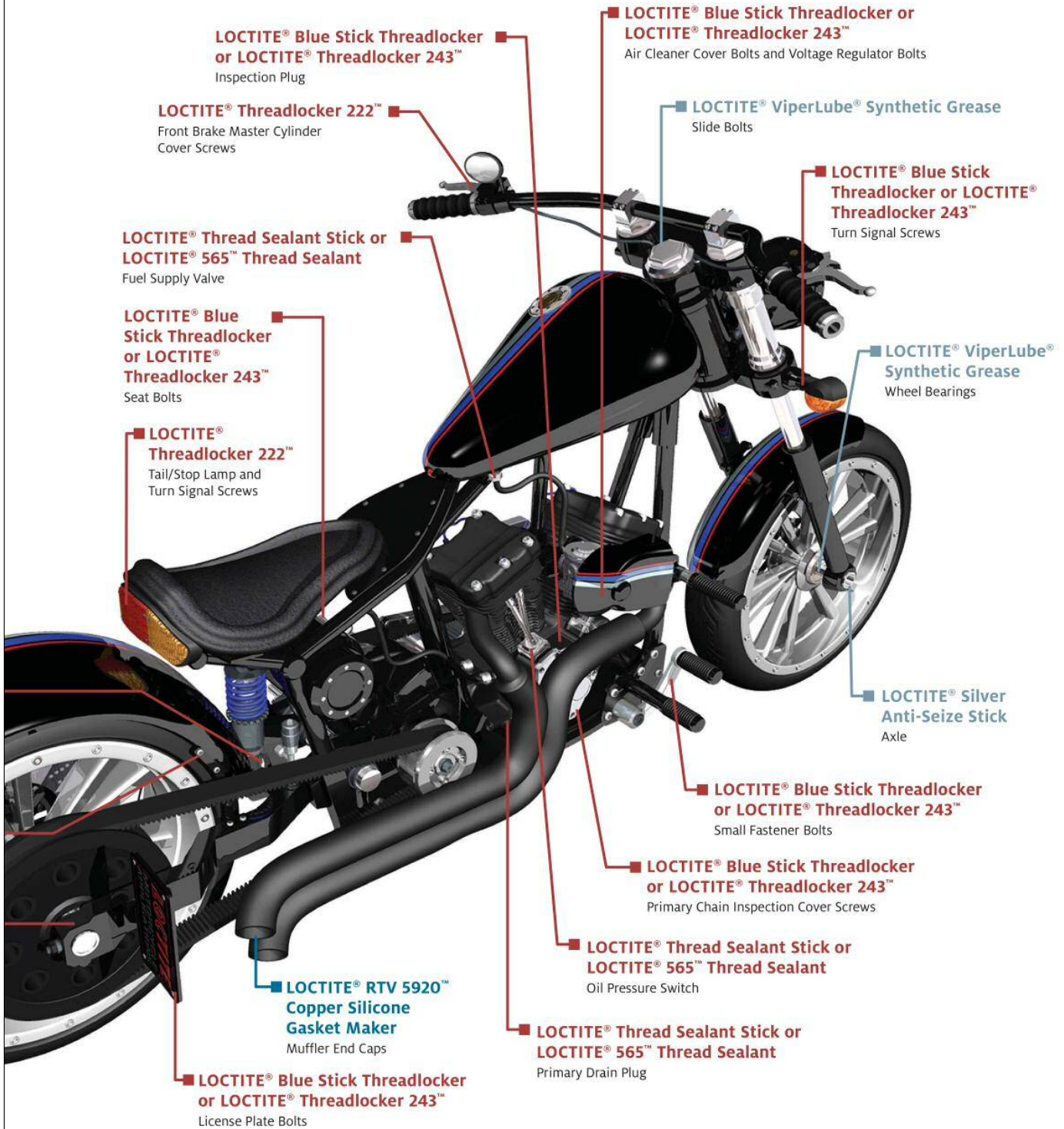

# MOTORCYCLE ENGINE

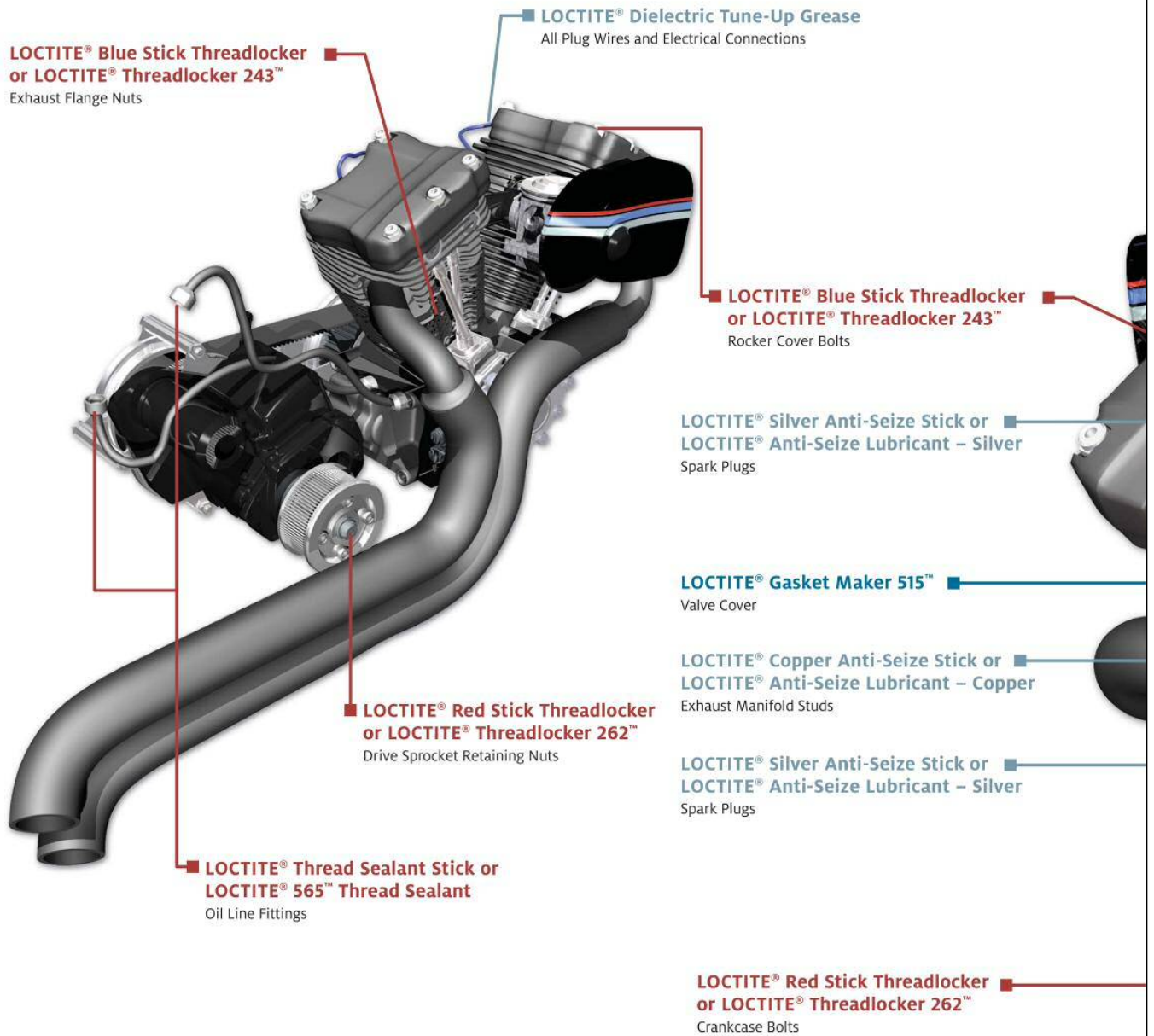

THREAD TREATMENTS

GASKETING

LUBRICANTS

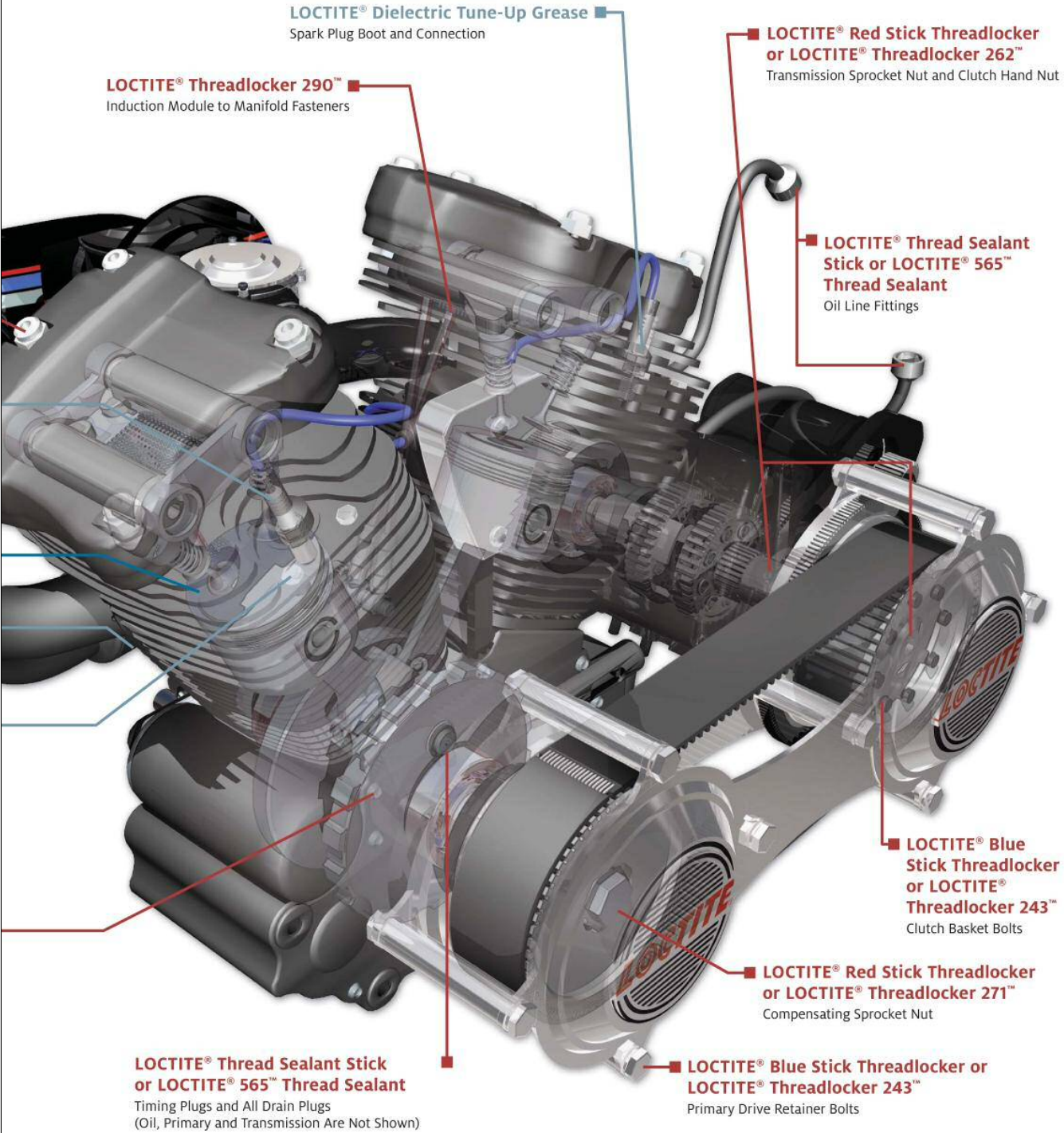

# MARINE INBOARD ENGINE

**LOCTITE® Threadlocker 222™**

Throttle controls, electrical mounting plate screws, drive water pump screws, air box cover screws, neutral start switch screw, stator screws, cowl latch bolts

**LOCTITE® Anti-Seize Lubricant – Copper**  
**LOCTITE® Anti-Seize Lubricant – Silver**

Prop shaft splines, mechanical joints, starter bushings, battery terminals, dress exhaust gaskets, external metal parts, threads, gears, chains, cables, pulleys, rollers

**LOCTITE® Thread Sealant Stick or**  
**LOCTITE® 592™ Thread Sealant**

Hydraulic lines, oil sender and switch, water pressure sender, water temperature sender, bleed fittings, telltale fittings



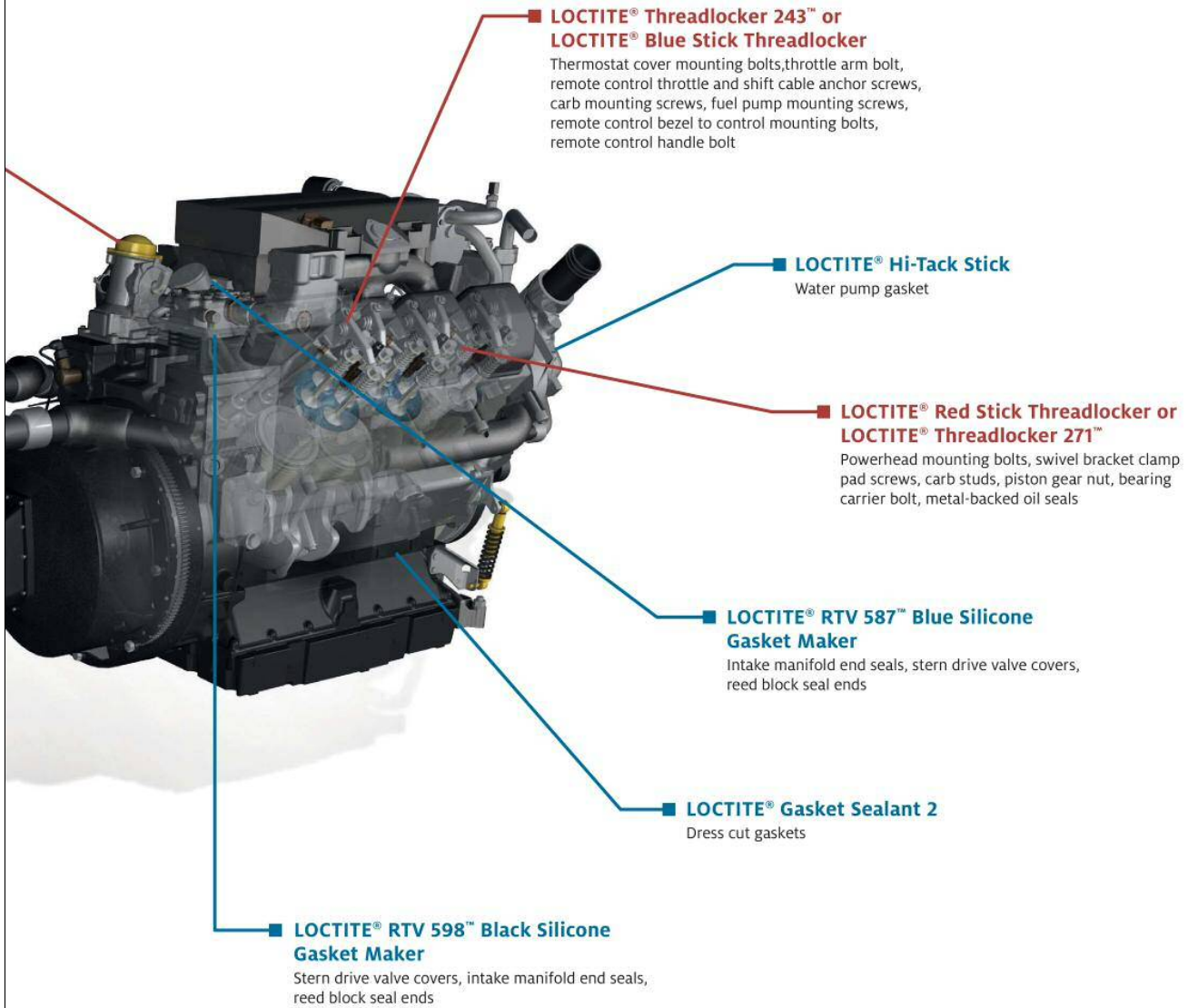

# MARINE OUTBOARD ENGINE

**LOCTITE® Red Stick Threadlocker or  
LOCTITE® Threadlocker 271™**  
Piston gear nut, powerhead mounting bolts, swivel  
bracket clamp pad screws, carb studs, bearing  
carrier bolt, metal-backed oil seals

**LOCTITE® Threadlocker 243™ or  
LOCTITE® Blue Stick Threadlocker**  
Fuel pump mounting screws, thermostat cover  
mounting bolts, throttle arm bolt, remote control  
throttle and shift cable anchor screws, carb mounting  
screws, remote control bezel to control mounting  
bolts, remote control handle bolt

**LOCTITE® Gasket Sealant 2**  
Dress cut gaskets

**LOCTITE® Bearing Mount 680™**  
Powerhead mounting studs, rewind studs,  
drive shaft housing studs

**LOCTITE® Hi-Tack Stick**  
Water pump gasket

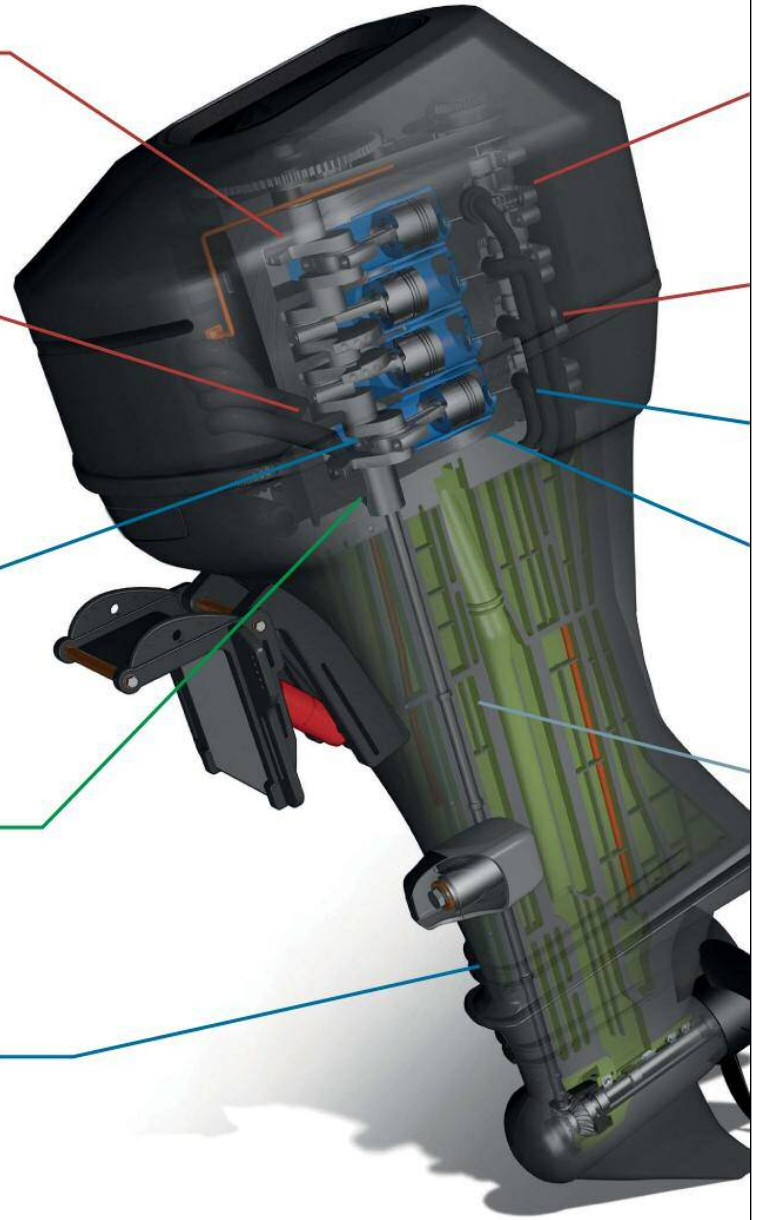



■ **LOCTITE® Thread Sealant Stick or  
LOCTITE® 592™ Thread Sealant**

Hydraulic lines, oil sender and switch, water pressure sender, water temperature sender, bleed fittings, telltale fittings

■ **LOCTITE® Threadlocker 222™**

Stator screws, throttle controls, electrical mounting plate screws, drive water pump screws, air box cover screws, neutral start switch screw, cowl latch bolts

■ **LOCTITE® RTV 587™ Blue Silicone  
Gasket Maker**

Intake manifold, valve covers, reed block seal ends

■ **LOCTITE® Gasket Maker 518™**

Seal outboard crankcase halves

■ **LOCTITE® Anti-Seize Lubricant – Copper  
LOCTITE® Anti-Seize Lubricant – Silver**

Prop shaft splines, mechanical joints, starter bushings, battery terminals, dress exhaust gaskets, external metal parts, threads, gears, chains, cables, pulleys, rollers

THREAD TREATMENTS

RETAINING COMPOUNDS

GASKETING

LUBRICANTS

# ADHESIVES AND SEALANTS DISPLAY

When you display quality products, they do the selling for you . . .



Display shipped without product. Sample assortment shown.

- You decide on the product mix that meets YOUR customers' needs
- Display the fastest moving LOCTITE® products for the most common maintenance and repair tasks
- Easy to display and alternate product mix
- High-quality, powder-coated aluminum display can be hung on your pegboard or placed on your counter
- Display header features the LOCTITE® brand name, which maintains 98% brand recognition!

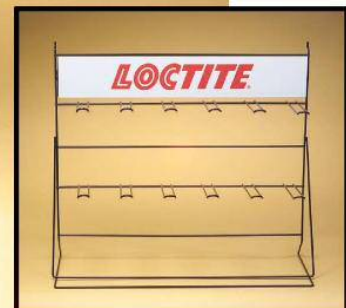

Contents:  
LOCTITE® Header  
12 display hooks  
(Product Not Included)

Dimensions:  
19.81" w x 8.12" d x 17.75" h

Item No: 40978

# AGENCY APPROVALS

## NSF International

### NON-FOOD COMPOUND

Loctite® Klean 'N Prime™  
 Loctite® Ready Gasket  
 Loctite® RTV 587™ Blue Silicone Gasket Maker, High Performance  
 Loctite® Threadlocker 242™, Medium Strength  
 Loctite® Threadlocker 262™, High Strength  
 Loctite® Threadlocker 290™, Wicking Grade

### STANDARD 51

Loctite® RTV Black Silicone, Adhesive/Sealant  
 Loctite® RTV Clear Silicone, Adhesive/Sealant

### H-1 RATING

Loctite® ViperLube® Synthetic Grease

## American Bureau of Shipping (ABS)

Loctite® Anti-Seize Lubricant, Silver  
 Loctite® Retaining Compound 620™, High Temperature  
 Loctite® Retaining Compound 660™, Relaxed Fits  
 Loctite® Extend® Rust Treatment  
 Loctite® RTV 587™ Blue Silicone Gasket Maker, High Performance  
 Loctite® RTV 598™ Black Silicone Gasket Maker, High Performance  
 Loctite® Threadlocker 242™, Medium Strength  
 Loctite® Threadlocker 262™, High Strength  
 Loctite® Thread Sealant 545™, Pneumatic/Hydraulic

## UL Classified/Listed for U.S.

Loctite® Gasket Maker 515™, Anaerobic  
 Loctite® 565™ Thread Sealant, High Performance  
 Loctite® 592™ Thread Sealant, High Temperature  
 Loctite® RTV 587™ Blue Silicone Gasket Maker, High Performance  
 Loctite® RTV Black Silicone, Adhesive/Sealant  
 Loctite® RTV Clear Silicone, Adhesive/Sealant  
 Loctite® Thread Sealant Stick  
 Loctite® Threadlocker 271™, Heavy-Duty

## ULC Classified for Canada

Loctite® 565™ Thread Sealant, High Performance  
 Loctite® 592™ Thread Sealant, High Temperature  
 Loctite® RTV Black Silicone, Adhesive/Sealant  
 Loctite® RTV Clear Silicone, Adhesive/Sealant  
 Loctite® Thread Sealant Stick

## CSA International

Loctite® 565™ Thread Sealant, High Performance  
 Loctite® Thread Sealant Stick

## Canadian Food Inspection Agency (CFIA)

Loctite® Anti-Seize Lubricant, Silver  
 Loctite® Anti-Seize Lubricant, Silver, Aerosol Can  
 Loctite® Aviation Gasket Sealant  
 Loctite® Retaining Compound 620™, High Temperature  
 Loctite® Retaining Compound 660™, For Worn Parts  
 Loctite® Retaining Compound 680™, Relaxed Fits  
 Loctite® Belt Dressing & Conditioner  
 Loctite® Black Weatherstrip Adhesive  
 Loctite® Blue Stick Threadlocker, Medium Strength  
 Loctite® Copper Anti-Seize Stick  
 Loctite® Extend® Rust Treatment  
 Loctite® Form-A-Thread® Stripped Thread Repair  
 Loctite® Gasket Maker 518™, Anaerobic  
 Loctite® Gasket Sealant 1  
 Loctite® Klean 'N Prime™  
 Loctite® Penetrating Oil  
 Loctite® 565™ Thread Sealant, High Performance  
 Loctite® 592™ Thread Sealant, High Temperature  
 Loctite® Red Stick Threadlocker, High Strength  
 Loctite® RTV 587™ Blue Silicone Gasket Maker, High Performance  
 Loctite® RTV 598™ Black Silicone Gasket Maker, High Performance  
 Loctite® RTV 5699™ Grey Silicone Gasket Maker, High Performance  
 Loctite® RTV Black Silicone, Adhesive/Sealant  
 Loctite® RTV Clear Silicone, Adhesive/Sealant  
 Loctite® RTV Red Silicone Gasket Maker, Sensor-Safe/High Temperature  
 Loctite® Silicone Lubricant  
 Loctite® Silver Anti-Seize Stick  
 Loctite® Threadlocker 222™, Low Strength  
 Loctite® Threadlocker 242™, Medium Strength  
 Loctite® Threadlocker 243™, Surface Insensitive  
 Loctite® Threadlocker 271™, Heavy-Duty  
 Loctite® Threadlocker 277™, Heavy-Duty/Large Bolts  
 Loctite® Threadlocker 290™, Penetrating  
 Loctite® Threadlocker 262™, High Strength  
 Loctite® Thread Sealant 545™, Pneumatic/Hydraulic  
 Loctite® Thread Sealant Stick  
 Loctite® Thread Sealant with PTFE  
 Loctite® ViperLube® Synthetic Grease  
 Loctite® ViperLube® Synthetic Grease, Aerosol  
 Loctite® Yellow Weatherstrip Adhesive  
 Loctite® QuickTape® 249™ Blue Threadlocker Tape, Medium Strength

## Military Specifications (Mil Spec)

Loctite® Retaining Compound 640™, High Strength  
 Loctite® Klean 'N Prime™  
 Loctite® Threadlocker 222™, Low Strength  
 Loctite® Threadlocker 242™, Medium Strength  
 Loctite® Threadlocker 262™, High Strength  
 Loctite® Threadlocker 271™, Heavy-Duty  
 Loctite® Threadlocker 277™, Heavy-Duty/Large Bolts  
 Loctite® Threadlocker 290™, Penetrating

# INDEX BY PRODUCT NAME

PRODUCT NAME	PAGE NUMBER
LOCTITE® 565™ Thread Sealant	12, 13
LOCTITE® 592™ Thread Sealant	12, 13
LOCTITE® 3092™ Adhesive	16
LOCTITE® All Purpose Spray Adhesive	19
LOCTITE® Anti-Seize Lubricant – Copper	29
LOCTITE® Anti-Seize Lubricant – Silver	29
LOCTITE® Aviation Gasket Sealant	25, 27
LOCTITE® Bearing Mount 620™	14, 15
LOCTITE® Bearing Mount 680™	14, 15
LOCTITE® Bearing Mount Stick	5, 15
LOCTITE® Belt Dressing & Conditioner	32
LOCTITE® Black Weatherstrip Adhesive	19
LOCTITE® Blue Stick Threadlocker	4, 5, 7, 11
LOCTITE® CA Mix Nozzle, (5) pack	16
LOCTITE® Clover® Lapping & Grinding Compound 280 Grit	34
LOCTITE® Copper Anti-Seize Stick	4, 5, 29
LOCTITE® Copper Gasket Adhesive	25, 27
LOCTITE® Dielectric Tune-Up Grease	31
LOCTITE® Disc Brake Quiet Stick	5, 30
LOCTITE® Epoxy Mixer Cups	18
LOCTITE® Epoxy Plastic Bonder	16
LOCTITE® Epoxy Quick Set™	16
LOCTITE® Extend® Rust Neutralizer	34
LOCTITE® Form-A-Thread® Stripped Thread Repair	35
LOCTITE® Freeze & Release	31
LOCTITE® Gasket Maker 515™	24, 26
LOCTITE® Gasket Maker 518™	24, 26
LOCTITE® Gasket Sealant 1	25, 27
LOCTITE® Gasket Sealant 2	25, 27
LOCTITE® Gear, Chain & Cable Lubricant	33
LOCTITE® Head Bolt & Water	13
LOCTITE® Hi-Tack Gasket Sealant	25, 27
LOCTITE® Hi-Tack Stick – Gasket Dressing	5, 24, 26
LOCTITE® Industrial Hand Wipes	35
LOCTITE® Insulating & Sealing Wrap	35
LOCTITE® Klean 'N Prime™	10
LOCTITE® LB 8027™ Engine Assembly Lube	31
LOCTITE® LB 8028™ Camshaft Lube	31
LOCTITE® LocWeld™ Bonding Compound	18
LOCTITE® Naval Jelly® Rust Dissolver	34
LOCTITE® Penetrating Oil	33
LOCTITE® Power Can Display Rack	21
LOCTITE® Power Grab® All-Purpose Clear Construction Adhesive	19

PRODUCT NAME	PAGE NUMBER
LOCTITE® Press Fit Repair 660™	14, 15
LOCTITE® Product Display (12 Hooks)	52
LOCTITE® Quick Gel® Super Glue	17
LOCTITE® QuickTape® 249™ Blue Threadlocker Tape	7, 11
LOCTITE® QuickTite® Super Glue Gel	18
LOCTITE® Ready Gasket	23, 27
LOCTITE® Rear Window Defogger	16
LOCTITE® Rearview Mirror Adhesive	16
LOCTITE® Red Stick Threadlocker	4, 5, 7, 11
LOCTITE® RTV 5699™ Grey Silicone Gasket Maker	22, 27
LOCTITE® RTV 587™ Blue Silicone Gasket Maker	22, 27
LOCTITE® RTV 5920™ Copper Silicone Gasket Maker	22, 27
LOCTITE® RTV 598™ Black Silicone Gasket Maker	22, 27
LOCTITE® RTV Black Silicone	18
LOCTITE® RTV Blue Silicone Gasket Maker	23, 27
LOCTITE® RTV Clear Silicone	18
LOCTITE® RTV Red Silicone Gasket Maker	23, 27
LOCTITE® Rubberized Undercoating	34
LOCTITE® Silicone Lubricant	33
LOCTITE® Silver Anti-Seize Stick	4, 5, 29
LOCTITE® Sleeve Retainer 640™	14, 15
LOCTITE® Spray Adhesive Professional Performance	19
LOCTITE® Stik 'N Seal® Extreme Conditions	19
LOCTITE® Super Glue Liquid	17
LOCTITE® Super Glue Longneck Bottle	17
LOCTITE® Super Glue Professional	17
LOCTITE® Super Glue Ultra Gel Control	17
LOCTITE® Super Glue Ultra Liquid Control	17
LOCTITE® Thread Sealant 545™	12, 13
LOCTITE® Thread Sealant Stick	4, 5, 12, 13
LOCTITE® Thread Sealant with PTFE	13
LOCTITE® Thread Treatment Sticks Counter Display	4
LOCTITE® Thread Treatment Sticks Kit	4
LOCTITE® Threadlocker 222™	7, 11
LOCTITE® Threadlocker 242®	8, 11
LOCTITE® Threadlocker 243™	8, 11
LOCTITE® Threadlocker 262™	8, 11
LOCTITE® Threadlocker 271™	8, 11
LOCTITE® Threadlocker 272™	9, 11
LOCTITE® Threadlocker 277™	9, 11
LOCTITE® Threadlocker 290™	9, 11
LOCTITE® ViperLube® Synthetic Grease	32
LOCTITE® Windshield Repair Kit	16
LOCTITE® Yellow Weatherstrip Adhesive	19

# INDEX BY PART NUMBER

PART NUMBER	PRODUCT NAME	PAGE NUMBER
03325	LOCTITE® Rearview Mirror Adhesive	16
03346	LOCTITE® Rearview Mirror Adhesive	16
21351	LOCTITE® Rear Window Defogger	16
24205	LOCTITE® Threadlocker 242™	8, 11
27105	LOCTITE® Threadlocker 271™	8, 11
28654	LOCTITE® Form-A-Thread® Stripped Thread Repair Kit	35
30544	LOCTITE® All Purpose Spray Adhesive	19
34943	LOCTITE® Industrial Hand Wipes	35
34944	LOCTITE® Industrial Hand Wipes	35
36781	LOCTITE® ViperLube® Synthetic Grease	32
36782	LOCTITE® ViperLube® Synthetic Grease	32
37391	LOCTITE® Quick Gel® Super Glue	17
37394	LOCTITE® Gasket Maker 518™	24, 26
37396	LOCTITE® 565™ Thread Sealant	12, 13
37397	LOCTITE® 592™ Thread Sealant	12, 13
37398	LOCTITE® 592™ Thread Sealant	12, 13
37418	LOCTITE® Threadlocker 242™	8, 11
37420	LOCTITE® Threadlocker 262™	8, 11
37421	LOCTITE® Threadlocker 271™	8, 11
37423	LOCTITE® Threadlocker 290™	9, 11
37424	LOCTITE® Sleeve Retainer 640™	14, 15
37438	LOCTITE® Rearview Mirror Adhesive	16
37460	LOCTITE® RTV Black Silicone	18
37461	LOCTITE® RTV Blue Silicone Gasket Maker	23, 27
37463	LOCTITE® RTV Clear Silicone	18
37464	LOCTITE® RTV 5699™ Grey Silicone Gasket Maker	22, 27
37465	LOCTITE® RTV 587™ Blue Silicone Gasket Maker	22, 27
37466	LOCTITE® RTV 5920™ Copper Silicone Gasket Maker	22, 27
37467	LOCTITE® RTV 598™ Black Silicone Gasket Maker	22, 27
37469	LOCTITE® RTV Red Silicone Gasket Maker	23, 27
37472	LOCTITE® RTV 598™ Black Silicone Gasket Maker	22, 27
37477	LOCTITE® Threadlocker 242™	8, 11
37478	LOCTITE® Threadlocker 262™	8, 11
37479	LOCTITE® Threadlocker 271™	8, 11
37480	LOCTITE® Threadlocker 272™	9, 11
37481	LOCTITE® Threadlocker 290™	9, 11
37482	LOCTITE® Thread Sealant 545™	12, 13
37484	LOCTITE® Sleeve Retainer 640™	14, 15
37485	LOCTITE® Bearing Mount 680™	14, 15
37509	LOCTITE® Klean 'N Prime™	10
37510	LOCTITE® Ready Gasket	23, 27
37512	LOCTITE® Ready Gasket	23, 27
37513	LOCTITE® Epoxy Mixer Cups	18
37516	LOCTITE® RTV 587™ Blue Silicone Gasket Maker	22, 27
37518	LOCTITE® RTV 598™ Black Silicone Gasket Maker	22, 27
37519	LOCTITE® RTV 598™ Black Silicone Gasket Maker	22, 27
37521	LOCTITE® RTV Clear Silicone	18
37523	LOCTITE® RTV Black Silicone	18
37525	LOCTITE® RTV Blue Silicone Gasket Maker	23, 27
37528	LOCTITE® RTV Red Silicone Gasket Maker	23, 27
37529	LOCTITE® RTV Red Silicone Gasket Maker	23, 27
37530	LOCTITE® Gasket Maker 518™	24, 26
37531	LOCTITE® LocWeld™ Bonding Compound	18
37532	LOCTITE® Black Weatherstrip Adhesive	19
37534	LOCTITE® Dielectric Tune-Up Grease	31
37535	LOCTITE® Dielectric Tune-Up Grease	31
37539	LOCTITE® Anti-Seize Lubricant	29
37542	LOCTITE® Gasket Sealant 1	25, 27
37544	LOCTITE® Gasket Sealant 2	25, 27
37555	LOCTITE® Hi-Tack Gasket Sealant	25, 27
37562	LOCTITE® Anti-Seize Lubricant	29
37565	LOCTITE® Anti-Seize Lubricant	29
37566	LOCTITE® Anti-Seize Lubricant	29
37578	LOCTITE® ViperLube® Synthetic Grease	32
37580	LOCTITE® Rubberized Undercoating	34
37581	LOCTITE® Belt Dressing & Conditioner	32

PART NUMBER	PRODUCT NAME	PAGE NUMBER
37582	LOCTITE® Gear, Chain & Cable Lubricant	33
37583	LOCTITE® Copper Gasket Adhesive	25, 27
37584	LOCTITE® Silicone Lubricant	33
37585	LOCTITE® Penetrating Oil	33
37613	LOCTITE® Windshield Repair Kit	16
37614	LOCTITE® Blue Stick Threadlocker	4, 5, 7, 11
37615	LOCTITE® Thread Sealant Stick	4, 5, 12, 13
37616	LOCTITE® Copper Anti-Seize Stick	4, 5, 29
37617	LOCTITE® Silver Anti-Seize Stick	4, 5, 29
37643	LOCTITE® Blue Stick Threadlocker	5, 7, 11
37700	LOCTITE® Red Stick Threadlocker	4, 5, 7, 11
37701	LOCTITE® Red Stick Threadlocker	5, 7, 11
38650	LOCTITE® Anti-Seize Lubricant	29
38651	LOCTITE® Press Fit Repair 660™	14, 15
38652	LOCTITE® Bearing Mount 620™	14, 15
38653	LOCTITE® Threadlocker 222™	7, 11
38655	LOCTITE® Gasket Maker 515™	24, 26
38656	LOCTITE® Threadlocker 277™	9, 11
38658	LOCTITE® Anti-Seize Lubricant	29
38725	LOCTITE® Thread Treatment Sticks Kit	4
39089	LOCTITE® Epoxy Mixer Cups	18
39123	LOCTITE® QuickTite® Super Glue Gel	18
39150	LOCTITE® Bearing Mount Stick	5, 15
39158	LOCTITE® Hi-Tack Gasket Dressing Stick	5, 24, 26
40300	LOCTITE® Disc Brake Quiet Stick	5, 30
40462	LOCTITE® RTV 587™ Blue Silicone Gasket Maker	22, 27
40463	LOCTITE® RTV 598™ Black Silicone Gasket Maker	22, 27
40464	LOCTITE® RTV Black Silicone	18
40465	LOCTITE® RTV Red Silicone Gasket Maker	23, 27
40480	LOCTITE® Ready Gasket	23, 27
40481	LOCTITE® RTV Clear Silicone	18
40482	LOCTITE® RTV Blue Silicone Gasket Maker	23, 27
40505	LOCTITE® RTV 5699™ Grey Silicone Gasket Maker	22, 27
40669	LOCTITE® Yellow Weatherstrip Adhesive	19
40978	LOCTITE® Product Display (12 Hooks)	52
75430	LOCTITE® Extend® Rust Neutralizer	34
230992	LOCTITE® Super Glue Longneck Bottle	17
633877	LOCTITE® Extend® Rust Neutralizer	34
996456	LOCTITE® Freeze & Release	31
1027663	LOCTITE® Power Can Display Rack	21
1158514	LOCTITE® Head Bolt & Water	13
1212164	LOCTITE® Insulating & Sealing Wrap	35
1291112	LOCTITE® 5th Wheel Grease	47
1330799	LOCTITE® Threadlocker 243™	8, 11
1330906	LOCTITE® Threadlocker 243™	8, 11
1360784	LOCTITE® Stik 'N Seal™ Extreme Conditions Contact Adhesive	19
1363118	LOCTITE® Epoxy Plastic Bonder	16
1363589	LOCTITE® Super Glue Ultra Gel Control	17
1365882	LOCTITE® Super Glue Professional	17
1372603	LOCTITE® QuickTape® 249™ Blue Threadlocker Tape	7, 11
1381191	LOCTITE® Naval Jelly® Rust Dissolver	34
1381192	LOCTITE® Extend® Rust Neutralizer	34
1395391	LOCTITE® Epoxy Quick Set™	16
1399967	LOCTITE® Super Glue Liquid	17
1434516	LOCTITE® CA Mix Nozzle, (5) pack	16
1496756	LOCTITE® Insulating & Sealing Wrap	35
1525607	LOCTITE® Aviation Gasket Sealant	25, 27
1533652	LOCTITE® Thread Sealant with PTFE	13
1537776	LOCTITE® Hi-Tack Gasket Sealant	25, 27
1540599	LOCTITE® Insulating & Sealing Wrap	35
1629134	LOCTITE® Spray Adhesive Professional Performance	19
1647358	LOCTITE® Super Glue Ultra Liquid Control	17
1777012	LOCTITE® Clover® Lapping & Grinding Compound 280 Grit	34
1787494	LOCTITE® LB 8027™ Engine Assembly Lube	31
1787977	LOCTITE® LB 8028™ Camshaft Lube	31
1804373	LOCTITE® Power Grab® All-Purpose Clear Construction Adhesive	19
1807961	LOCTITE® 3092™ Adhesive	16

**LOCTITE®**

**U.S.A.**

**Henkel Corporation**  
Engineering Adhesives  
One Henkel Way  
Rocky Hill, Connecticut 06067  
Tel: 1.800.LOCTITE (562.8483)  
Tel: 860.571.5100  
Fax: 860.571.5465

**Canada**

**Henkel Canada Corporation**  
Engineering Adhesives  
2515 Meadowpine Blvd.  
Mississauga, Ontario L5N 6C3  
Tel: 1.800.263.5043 (*within Canada*)  
Tel: 905.814.6511  
Fax: 905.814.5391

[www.henkelna.com/aam](http://www.henkelna.com/aam)  
[www.loctite.com](http://www.loctite.com)

Except as otherwise noted, all marks used are trademarks and/or registered trademarks of Henkel and/or its affiliates in the US and elsewhere. ® = registered in the U.S. Patent and Trademark Office. Delrin is a registered trademark of E.I. du Pont de Nemours and Company. CRC is a trademark of CRC Industries, Inc. Inconel and Monel are trademarks of Huntington Alloys Corporation. Iridite is a trademark of MacDermid Acumen, Inc. Kovar is a trademark of CRS Holdings, Inc. Permatex is a trademark of Illinois Tool Works, Inc. Mylar is a registered trademark of DuPont Teijin Films. U.S. Naval Jelly is a registered trademark of Naval Jelly Company, LP. © 2014 Henkel Corporation. All rights reserved. 11898/LT-3770 (1/14)